



Operating Instructions

Puridest Mono Distillation Apparatus
PD 2, PD 4



LAUDA Puridest Mono Distillation Apparatus models PD 2 and PD 4 produce distillate of good quality with a low conductivity (approx. $2.3 \mu\text{S} / \text{cm}$ at $25 \text{ }^\circ\text{C}$), dependent on quality and composition of the feed water.

Before installation, please check whether contents of package are in good order and complete.

Should you note any damages or have any reasons for complaint, please contact your supplier or directly:

LAUDA DR. R. WOBSE GMBH & CO. KG

Schulze-Delitzsch-Str. 4+5

30938 Burgwedel - Germany

Phone: +49 (0)5139 9958 0

Fax: +49 (0)5139 9958 21

Email: info@lauda.de

Internet: <https://www.lauda.de>

Translation of the original operating instructions

Q4DT-E_13-006-EN-01, 28.06.2023

© 2023 LAUDA DR. R. WOBSE GMBH & CO. KG

Contents

Operating Instructions	1
1 Use of the Distillation Apparatus	7
1.1 Intended Use.....	7
1.2 Improper Use	7
2 Warranty conditions.....	7
3 Before Initiation	8
4 Set-up and Location of the Distillation Apparatus	8
5 Operating Voltage.....	8
6 Water Connections	9
6.1 Tap water inlet (ill. A).....	9
6.2 Cooling water outlet (ill. B).....	9
6.3 Destillate Outlet	9
7 Initiation and Setting of the Cooling Water Temperature.....	10
7.1 Control Thermometer (ill. C)	10
7.2 Water inlet and Setting the Cooling Water Temperature (ill. D and E)	10
7.3 Degassing and Distillate Withdrawal (ill. F)	10
8 Functional Description	11
9 Maintenance, Service and Removal of Malfunctions	11
9.1 Descaling	11
9.2 Cleaning.....	12
9.3 Re-Initiation after Low Water	12
9.4 Technical support.....	12
10 Disposal of Old Units.....	12
11 Technical Data	13
12 Circuit diagram	14
12.1 Circuit diagram PD 2	14
12.2 Circuit diagram PD 4	14
13 Connection to the mains supply	15
13.1 Electrical fuses	15
13.2 Examples for connection to the mains supply.....	16
14 Accessories.....	17
15 Notes	18

16	Ordering spare parts / LAUDA Service.....	19
17	Product Returns and Clearance Declaration	20
18	EC Declaration of Conformity and certificates.....	21

1 Use of the Distillation Apparatus

1.1 Intended Use

In LAUDA Puridest Mono Distillation Apparatus PD 2 and PD 4, an electric heating element serves to boil water and transform it to steam. The steam is led into the condenser that is placed on the boiler and condenses on the cooling coil. The produced distillate drains through a drain tube on the front of the condenser. Depending on the model, the distillate quantity is 2 litres (PD 2) or 4 litres (PD 4).

Depending on the tap water quality, the produced distillate has a conductivity of approx. $2.3 \mu\text{S} / \text{cm}$ at $25 \text{ }^\circ\text{C}$. To feed the Distillation Apparatus, preferably use tap water of drinking quality. Please also observe the information in chapters 15 of these instructions on the possible use of filters and cartridges to pretreat the tap water.

The Distillation Apparatus must be operated within the user's field of vision.



The information contained in these operating instructions must by all means be read and observed. Only then a perfect operation of the Distillation Apparatus can be guaranteed. The units may only be installed and operated by persons who have made themselves familiar with these operating instructions.



Caution:

Both the outer housing of the boiler and the steam condenser get strongly heated up during operation. Both parts may only be touched after they have cooled down, or when using suitable safety gloves.

1.2 Improper Use





LAUDA Puridest Mono Distillation Apparatus, operated in a laboratory, are no Medical Devices. They fall neither under national nor international Medical Device Directives and have to be used and applied accordingly. The Distillation Apparatus may not be used in potentially explosive surroundings. The Distillation Apparatus may neither be set up nor operated in laboratory areas with aggressive or corrosive ambient conditions.

2 Warranty conditions

LAUDA offers a standard 12 month manufacturer's warranty from the date of purchase.

3 Before Initiation

Important information are marked in bold letters in these instructions, safety indications are additionally marked by the following warning symbols and mandatory signs.

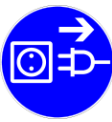
	Read and observe the operating instructions			
	Warning of hot liquids and vapour		Warning of hot surfaces	
	Warning of dangerous electrical voltage		General warning	
				Before maintenance and repair disconnect the unit all-pole from the electrical mains (pull the plug from the socket).

4 Set-up and Location of the Distillation Apparatus

	All free openings of the water connections on the right-hand side of the unit are taped close. These transport protections have to be removed before installation. Place on solid, even and level surfaces inside buildings only. Make sure to place the unit only on a watertight, temperature-resistant, non-flammable surface. The location must provide sufficient space as well as the necessary carrying capacity for the unit (unit weight as per technical data, chapter 11 of this manual, plus weight of the filling. The unit is not suitable for use in potentially explosive areas.
---	--

5 Operating Voltage

	The Distillation Apparatus must be connected to the mains through a correctly installed shock-proof socket or through an on-site main switch. The Distillation Apparatus is a protection class I electrical appliance, a connection to the earth conductor (PE) must be ensured. For information on the required mains fuse please view Technical Data 11 of this manual.
---	---

	The electrical connection must ensure an all-pole separation of the Distillation Apparatus from the mains at any time. The mains connection cable must not touch any hot surfaces of the unit. It may not lead underneath the unit. The main switch of the unit must be off (position O). The voltage on the nameplate (at the back of the unit) must be identical to the mains voltage. If they are identical, connect the unit to the mains. For further information, please also refer to chapter 13 of these operating instructions "Connection to the Mains Supply".
---	---

6 Water Connections

All water connections of the Distillation Apparatus, with the exception of the distillate withdrawal at the front, are located at the right-hand side of the unit. Hoses for water inlet and outlet are not included in the standard scope of supply.

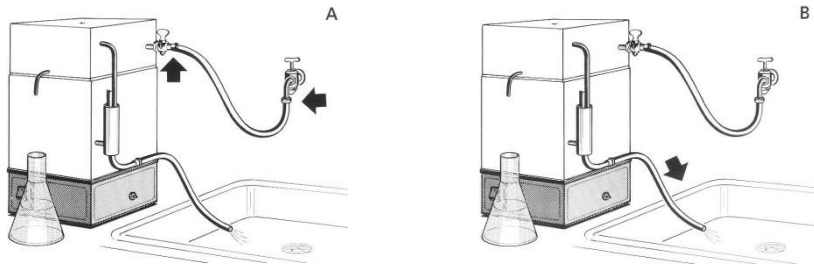

6.1 Tap water inlet (ill. A)

Water is fed to the Distillation Apparatus through the tap water inlet. Connect a $\frac{1}{2}$ " pressure hose between the tap for cooling water inlet and an on-site manual stop valve of the mains water supply. Make sure to secure both hose connections with hose clips!

6.2 Cooling water outlet (ill. B)

Connect a $\frac{1}{2}$ " temperature-resistant hose with a maximum length of 1.5 m to the cooling water outlet. The hose must lead into a drain on a lower level and must have a slope on its complete length. Make sure the cooling water can drain without back draughts.



Caution:

The cooling water leaves the Distillation Apparatus with a temperature up to 70 °C.
Danger of scaldings!

6.3 Distillate Outlet

Use a temperature-resistant hose (not depicted) to connect the distillate outlet tube on the front of the condenser with a storage tank (to be provided on-site). When choosing the storage tank, observe the special storage conditions for distilled water according to your requirements as well as the high temperature of freshly produced distillate.



Caution:

Distilled water leaves the Distillation Apparatus with a temperature up to 100 °C.
Danger of scaldings!

7 Initiation and Setting of the Cooling Water Temperature

Lift the condenser from the boiler (ill. E, upwards arrow) and fill in water until the heating element in the boiler is completely covered by water.

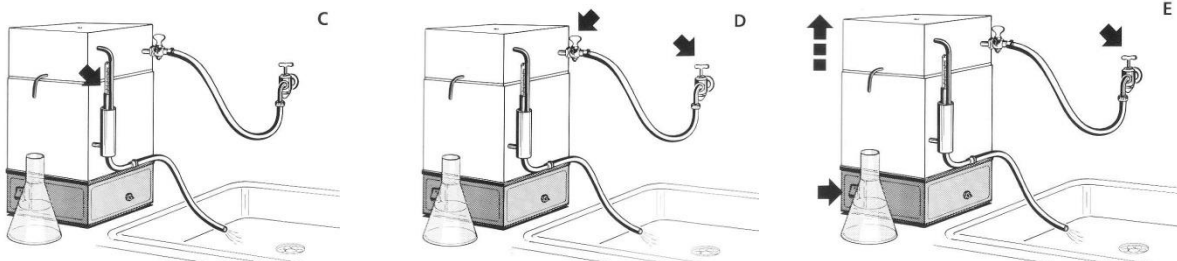

7.1 Control Thermometer (ill. C)

Insert the supplied thermometer into the tube support on the right-hand of the upper part.

7.2 Water inlet and Setting the Cooling Water Temperature (ill. D and E)

Open the tap of the cooling water supply on the unit completely (handle in the direction of water flow), and the on-site stop valve of the mains water supply a little. Check the power supply and switch on the main switch. The pilot lamp in the main switch lights up. As soon as the water in the boiler reaches boiling point, regulate the cooling water supply on the tap of the mains water supply so as to set the temperature of the draining cooling water to approx. 60 °C to 70 °C. The temperature can be checked with the inserted thermometer. The Distillation Apparatus achieves its maximum efficiency with a cooling water temperature of 60 °C to 70 °C.

7.3 Degassing and Distillate Withdrawal (ill. F)

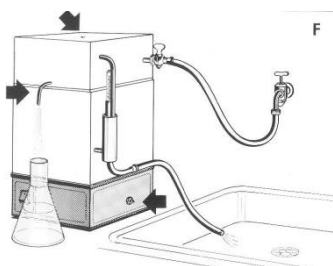

Carbon dioxide that forms during the distillation process, is released through a vent in the condenser. Produced distillate is to be led through a hose (not shown) from the drain tube into a storage tank.

8 Functional Description

The tap water flows through the cooling coil in the condenser to the water level regulator on the right-hand side of the unit. The mechanical water level regulator determines the water level in the boiler so as to ensure that the heating element is constantly kept below water level. Water that is not used for evaporation flows off through the cooling water outlet. When the heating element is switched on, it brings the water in the alembic to the boil. A thermostatic low water cut-off protects the heating element from running dry. The produced steam is led into the condenser, condenses on the cooling coil and drips off as distillate through the drain tube on the front. By setting the temperature of the cooling water between 60 °C and 70 °C, to be checked with the inserted thermometer, the unit's efficiency and the produced quantity of distillate is optimised.

9 Maintenance, Service and Removal of Malfunctions



Caution:
Before servicing the unit let the Distillation Apparatus cool down!
Danger of burns!

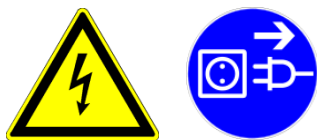

Caution:
Before opening the Distillation Apparatus as well as before cleaning procedures, disconnect the unit from the mains! (Unplug the unit or switch off the main switch).
Danger of electrical shock!

9.1 Descaling

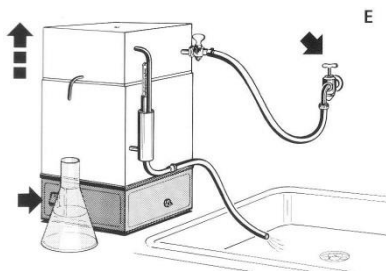

^E Depending on the hardness of the tap water, the Distillation Apparatus must be cleaned from scale formations in regular intervals. To do so, close the on-site water supply valve and lift the condenser from the boiler. A suitable descaling agent is a mixture of 10 % formic acid, 10 % acetic acid and 80 % distilled water. Fill the solvent into the boiler until it covers the topmost scale deposits and heat up to maximum approx. 70 °C. Make absolutely certain not to bring the mixture to a boil.

Pour the scale-solvent mix from the boiler after approx. 30 minutes and then rinse the boiler thoroughly with tap water. Commercial descaling agents, suitable for use with stainless steel, can also be used according to the manufacturer's instructions (e. g. rea-calc® of M/s CHEMOTEC GmbH, 63486 Bruchköbel, Germany). Never use any products containing hydrochloric acid! These will lead to damages to heating element, boiler, temperature sensor and the ducts of the screw connections. Restart the unit as described in chapter 7. After descalings, the first few litres of distillate should not be used as it might contain traces of evaporated descaling agent.

9.2 Cleaning

Depending on the degree of impurities in the feed water and the growing contamination of the water in the boiler, caused by the distilling process itself, the boiling process will cause foam formation. To prevent these impurities from migrating into the pure water area of the condenser, the water in the boiler must be exchanged at least twice a week. To do so, close the on-site water inlet valve and lift the condenser from the boiler. Then empty the contents from the boiler and rinse thoroughly with tap water.

Restart the unit as described in chapter 7.

The "Cleaning" procedure serves to exchange contaminated water in the boiler against clean water.

9.3 Re-Initiation after Low Water



In case of low water, the Distillation Apparatus temperature limiter will switch off the unit. In order to restart, allow the unit to cool down and, as described in chapter 7, fill water into the boiler until the heating element is below water level. The triggered low water cut-off must be released. To do so, loosen the black cap nut at the right-hand bottom of the Distillation Apparatus. Inside the thread, a small white plastic pin can be seen, that has to be gently pressed inside (e. g. with a pen) until a clicking sound can be heard.

The LAUDA Puridest Distillation Apparatus is produced with first-class materials. Nevertheless, the unit should only be subjected to mechanical strain in sensible limits. Make sure that no fluids come into contact with cable connections or the electrical parts inside the unit!

The powder-coated surfaces of the unit can be cleaned with mild detergents, if necessary.

Servicings, repairs or modifications must be carried out according to the General Engineering by a competent electrician.

Only original spare parts must be used. Always demand a detailed confirmation by the person in charge (company, date, signature) on the kind and volume of the tasks carried out.

9.4 Technical support

You can call our customer service at any time for technical support relating to LAUDA Puridest Mono Distillation Apparatus appliances.

Phone : +49 (0) 9343 / 503-350

Fax : +49 (0)9343 503-283

Email : service@lauda.de

Maintenance, repairs and modifications must be carried out by a qualified electrician (section 2 (3) DGUV Regulation 3) according to the General Rules of Technology (section 2 (2) DGUV Regulation 3). Only original spare parts may be used. Request that the person performing the work provides written confirmation of the type and scope of the work carried out (company, date, signature).

10 Disposal of Old Units

LAUDA will take responsibility, within the scope of the legal directives, for an environmentally sound handling and disposal of all used LAUDA units as of the production year 1995 that are returned to us free of charge and will have it materially recycled. Before the unit is returned, a legally binding declaration must be provided from the sender, confirming that the unit is free from harmful and/or hazardous contaminations as well as from hazardous substances caused by the previous use of the unit. LAUDA laboratory apparatus are exclusively designed for industrial use and may not be disposed of through public waste disposal authorities.

EAR Registration Number WEEE-ID.NO.DE 67770231

11 Technical Data

	PD 2	PD 4
Exterior dimensions (W x D x H)	270 mm x 250 mm x 510 mm	270 mm x 250 mm x 510 mm
Distillation capacity	2 l / h distillate	4 l / h distillate
Distillate quality	Mono distillate approx. 2.3 µS / cm at 25 °C	Mono distillate approx. 2.3 µS / cm at 25 °C

The conductivity of the distilled water is directly related to the chemical composition of the feed water. Components of the feed water having the same of a lower evaporation point than water may deteriorate the conductivity.

Cooling water requirement	20 l / h	40 l / h
Low water cut-off (thermostat)	Electromechanical temperature limiter, with capillary tube sensor. Switch-off temperature 135 °C / -15 K	Electromechanical temperature limiter, with capillary tube sensor. Switch-off temperature 135 °C / -15 K
Required cooling water pressure	1-2 bar 14.5 psi / 29.0 psi	1-2 bar 14.5 psi / 29.0 psi
Electrical connection / Mains connection	230 V +/- 10 %, 50 / 60 Hz, 2.0 kW Schuko plug CEE 7/7	230 V +/- 10 %, 50 / 60 Hz, 3.0 kW Schuko plug CEE 7/7

Caution! Mains voltage deviations, even within the mentioned limits, influence the quantity of distillate produced!

Mains fuse		
On-site	10 Amp. (max. 16 A)	16 Amp.
Internal	10 Amp. inert	15 Amp. inert
Protection class / - type	I / IP20	I / IP20

Surrounding conditions	Use only inside buildings (not in potentially explosive areas).	Use only inside buildings (not in potentially explosive areas).
Height above MSL	up to 2000 m MSL	up to 2000 m MSL
Ambient temperature	+10 °C to +40 °C	+10 °C to +40 °C
Humidity	max. 80 % rel. humidity to 31 °C, decreasing to 40 % rel. humidity at 40 °C	max. 80 % rel. humidity to 31 °C, decreasing to 40 % rel. humidity at 40 °C

Net weight	7.7 kg	8.0 kg
Weight with water filling	12.2 kg	12.5 kg

12 Circuit diagram

- E1 Tubular heating element
- F1 Fuse 10 Amp. inert (PD 2)
Fuse 15 Amp. inert (PD 4)
- F2 Fuse 10 Amp. inert (PD 2)
Fuse 16 Amp. inert (PD 4)
- F3 Low water cut-off (thermostat)
- K1 Contactor (PD 4)
- S1 Main switch

12.1 Circuit diagram PD 2

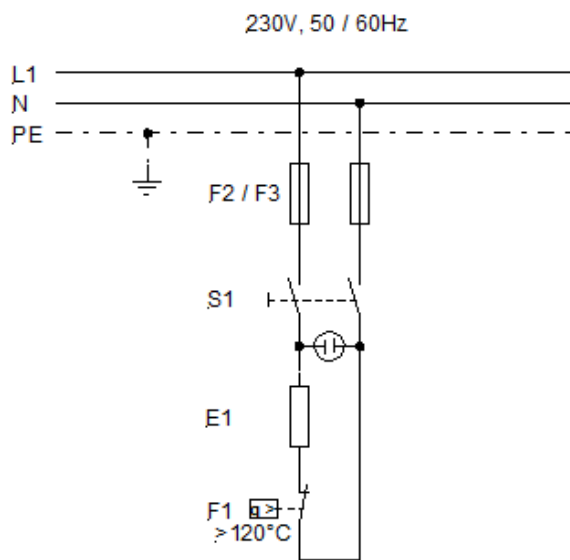

12.2 Circuit diagram PD 4

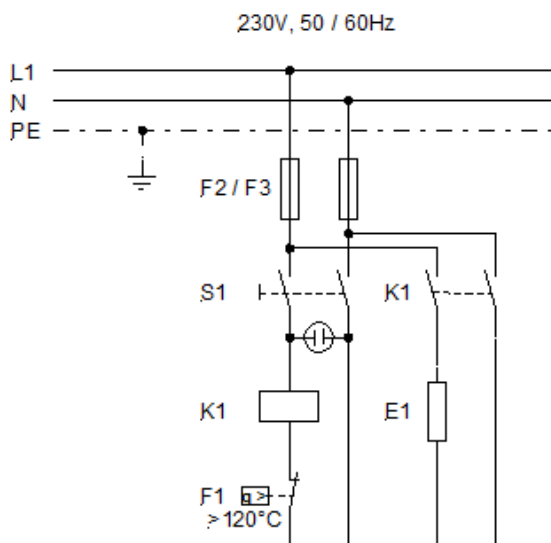

13 Connection to the mains supply

Distillation Apparatus models PD 2 and PD 4 are supplied with a pre-assembled, cast-on shock-proof plug (CEE 7/7). Make sure to connect to a protective conductor terminal.

Colour coding of the mains cable	Mains supply
ge/gr – yellow/green	PE (Protective earth)
bl – blue	N
sw – black	L1

Models PD 2 and PD 4 supplied for 230 V (see information on the nameplate) can be connected to all power supplies of 220 V or 230 V.

13.1 Electrical fuses

Model	Power	Power consumption at mains voltage *	Mains fuse (F4, F5)
PD 2	2.0 kW	8.7 A at 230 V	10 Amp
PD 4	3.0 kW	13.0 A at 230 V	16 Amp

* see nameplate

13.2 Examples for connection to the mains supply

Components

- B1 Shock-proof socket (on-site)
- B2 Shock-proof plug (mounted on the unit)
- F4 Mains fuse (on-site)
- F5 Mains fuse (on-site)
- S2 Main switch (on-site)

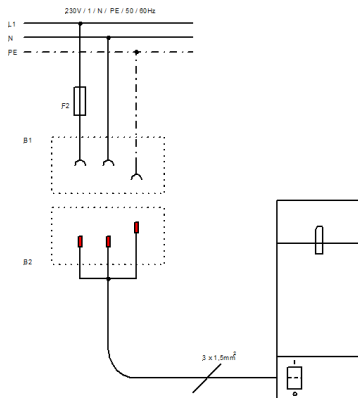

PD 2 und PD 4
with mains supply 230 V / N / PE / 50 / 60 Hz,
connected through 3-pole shock-proof plug system.

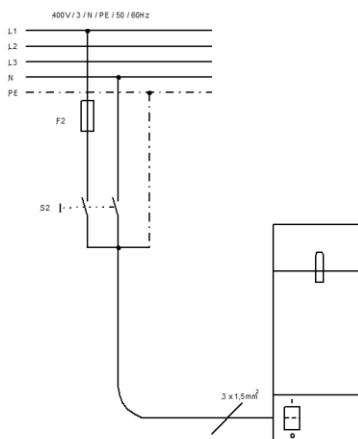

PD 2 und PD 4 for 230 V
with mains supply 400 V / 3 ~ / N / PE / 50 / 60 Hz
connected through on-site main switch.

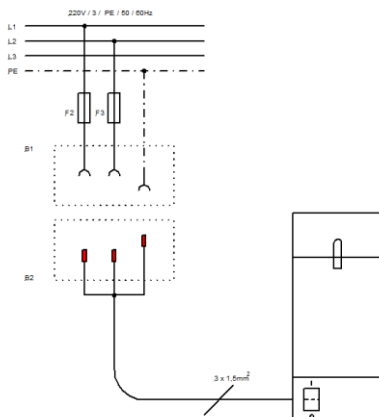

PD 2 und PD 4
with mains supply 220 V / 3 ~ / PE / 50 / 60 Hz
connected through 3-pole shock-proof plug system.

14 Accessories

Dechlorite Filter eliminates chlorine particles in tap water added by the local waterworks. Complete with connection for pressure hose ½ inch, with first filling.



Dechlorite Filter
Part No. A000129



Spare filling
Part No. A000130

Phosphate cartridge prevents scale formation in the condenser by phosphatising of tap water. Can be used from 4 to 15 °dH (German hardness), equivalent to approx. 0.7 to 2.7 mMol / l. With connection for pressure hose ½ inch, with first filling.



Phosphate cartridge
Part No. A000131



Spare filling
Part No. A000132

Pre-Filter 1 µm, for pre-cleaning the tap water, and to protect the unit from premature contamination. Complete with connections for pressure hose ½ inch, including filter candle. The candle should be replaced after maximum 6 months.



Pre-Filter with candle
Part No. A000133



Spare candle
Part No. A000134

Wall bracket, for one filter or for filter combinations of two or three filters, including sleeves to connect the filters as well as screws to fix the filters to the wall bracket.

A data sheet on possible connection variants of articles A000129, A000131 and A000133 can be supplied on request.



Wall bracket for one filter
Part No. A000136



Set of all 3 filters, incl. wall bracket
and fillings, mounted completely
Part No. A000135

Hose Set, consisting of hoses for water inlet and outlet (length 1.5 m), including hose clips.



Hose Set
Part No. A000137

16 Ordering spare parts / LAUDA Service

When ordering spare parts, please state the serial number (type plate) to avoid queries and wrong deliveries.

Your partner for maintenance and competent service support:

LAUDA Service
Phone: +49 (0)9343 503-350
Fax: +49 (0)9343 503-283
Email: service@lauda.de

We are always at your disposal for questions and suggestions!

LAUDA DR. R. WOBSE GMBH & CO. KG
Laudaplatz 1
97922 Lauda-Königshofen
Germany
Phone: +49 (0)9343 503-0
Fax: +49 (0)9343 503-222
Email info@lauda.de
Internet: <http://www.lauda.de/>

17 Product Returns and Clearance Declaration



Product Returns and Clearance Declaration

Product Returns

Would you like to return a LAUDA product you have purchased to LAUDA? For the return of goods, e.g. for repair or due to a complaint, you will need the approval of LAUDA in the form of a *Return Material Authorization (RMA)* or *processing number*. You can obtain the RMA number from our customer service department at +49 (0) 9343 503 350 or by email service@lauda.de.

Return address

LAUDA DR. R. WOBSEY GMBH & CO. KG
Laudaplatz 1
97922 Lauda-Königshofen
Deutschland/Germany

Clearly label your shipment with the RMA number. Please also enclose this fully completed declaration.

RMA number	Product serial number
Customer/operator	Contact name
Contact email	Contact telephone
Zip code	Place
Street & house number	
Additional explanations	

Clearance Declaration

The customer/operator hereby confirms that the product returned under the above-mentioned RMA number has been carefully emptied and cleaned, that any connections have been sealed to the farthest possible extent, and that there are no explosive, flammable, environmentally hazardous, biohazardous, toxic, radioactive or other hazardous substances in or on the product.

Place, date	Name in block letters	Signature

Version 02 - EN



EC DECLARATION OF CONFORMITY

Manufacturer: LAUDA DR. R. WOBSEER GMBH & CO. KG
Schulze-Delitzsch-Straße 4+5, 30938 Burgwedel, Germany

We hereby declare under our sole responsibility that the machines described below

Product Line: Puridest **Serial number:** from 220_____

Types: PD 2, PD 4,
PD 2 D, PD 4 D, PD 8 D,
PD 2 G, PD 2 DG, PD 4 G, PD 4 DG, PD 8 G,
PD 2 R, PD 4 R, PD 8 R and PD 12 R

comply with all relevant provisions of the EC Directives listed below due to their design and type of construction in the version brought on the market by us:

Machinery Directive	2006/42/EC
EMC Directive	2014/30/EU
RoHS Directive	2011/65/EU in connection with (EU) 2015/863

The protective objectives of the Machinery Directive with regard to electrical safety are complied with in accordance with Annex I Paragraph 1.5.1 in conformity with the Low Voltage Directive 2014/35/EU.

Applied standards:

- EN 61326-1:2013
- EN 61010-1:2010/A1:2019/AC:2019-04
- EN IEC 61010-2-010:2020

Authorized representative for the composition of the technical documentation:

Dr. Jürgen Dirscherl, Head of Research & Development

Burgwedel, 05.06.2023

Dr. Alexander Dinger,
Head of Quality and Environmental Management

LAUDA DR. R. WOBSEER GMBH & CO. KG

Schulze-Delitzsch-Straße 4+5 • 30938 Burgwedel • Germany

Phone.: +49 (0) 5139 9958-0 • Fax +49 (0) 5139 9958-21

Email: info@lauda.de • Internet: <https://www.lauda.de>