



Operation manual

Variocool

VC 1200 (W), VC 2000 (W), VC 3000 (W), VC 5000 (W), VC 7000 (W), VC 10000 (W)

Process thermostat

LAUDA DR. R. WOBSEER GMBH & CO. KG

Laudaplatz 1

97922 Lauda-Königshofen

Germany

Telephone: +49 (0)9343 503-0

E-mail: info@lauda.de

Internet: <https://www.lauda.de>

Translation of the original operation manual

Q4WA-E_13-002, 10, en_US ©LAUDA 2020

replaces issue V10R7, V9R8, V8R8, V7R11, V7R10, V7R7, V6R17, V5R19, V5R18, V5R16, V5R12, V5R05, V4R22, V3R101, V3R100

02/19/2024

Table of contents

1	Safety.....	7
1.1	General safety instructions.....	7
1.2	Obligations of the operator.....	7
1.3	Observing additional operating instructions.....	8
1.4	Intended Use.....	8
1.5	Foreseeable misuse.....	8
1.6	EMC requirements.....	9
1.7	Software versions.....	9
1.8	Prohibition of modifications to the device.....	10
1.9	Fluorinated refrigerant.....	10
1.10	Requirements for the heat transfer liquid.....	10
1.11	Materials.....	10
1.12	Hose requirements.....	10
1.13	Application area.....	10
1.14	Personnel qualification.....	11
1.15	Personal protective equipment.....	11
1.16	Product safety label.....	12
1.17	Structure of warnings.....	12
2	Unpacking.....	13
3	Device description.....	14
3.1	Device types.....	14
3.2	Setup of the device.....	15
3.3	Operating elements.....	17
3.3.1	Mains switch.....	17
3.3.2	Display buttons.....	18
3.4	Functional elements.....	18
3.4.1	Hydraulic circuit.....	18
3.4.2	Cooling unit.....	18
3.4.3	Interfaces.....	19
3.5	Equipment.....	21
3.6	Type plate.....	22
4	Before starting up.....	23
4.1	Installation.....	23
4.2	Connecting the consumer.....	24
4.2.1	Thermostatic hoses and hose clips.....	24
4.2.2	Connecting an external consuming unit.....	25
4.3	Cooling water.....	26

4.3.1	Cooling water requirements.....	26
4.3.2	Connecting the cooling water.....	27
4.4	Interfaces.....	28
4.4.1	Interface potential-free contact.....	28
4.4.2	Installing modules.....	29
5	Commissioning.....	30
5.1	Heat transfer liquids.....	30
5.2	Establishing power supply.....	31
5.3	Switching on the device for the first time and filling with liquid.....	31
5.3.1	Fill mode.....	31
5.3.2	Switch on the device and fill it.....	33
5.4	Setting the pump pressure.....	34
6	Operation.....	36
6.1	General safety instructions.....	36
6.2	Operating modes.....	36
6.3	Menu structure overview.....	37
6.4	Switching on the device.....	39
6.5	The display.....	39
6.5.1	Home window.....	39
6.5.2	Menu window.....	40
6.5.3	Entry window.....	41
6.5.4	Lock and release operating buttons.....	42
6.6	Define temperature limits.....	43
6.7	Specifying the set point.....	44
6.8	Activating and deactivating standby.....	44
6.9	SmartCool (cooling).....	44
6.10	External control.....	45
6.10.1	Activating the external control.....	45
6.10.2	Specifying the set point offset.....	45
6.11	Control.....	46
6.11.1	Basics.....	47
6.11.2	Opening the control menu.....	49
6.11.3	Overview of internal control parameters.....	50
6.11.4	Adapting internal control parameters.....	50
6.11.5	Overview of external control parameters.....	51
6.11.6	Adjusting external control parameters.....	52
6.12	Basic settings.....	53
6.12.1	Calling the basic settings.....	53
6.12.2	Adjusting the volume of the signal tones.....	53

6.12.3	Adjusting the display brightness.....	53
6.12.4	Specifying the starting mode (Auto start).....	54
6.12.5	Limiting the current consumption.....	55
6.12.6	Configuring the alarm level for the fill level.....	55
6.12.7	Setting the alarm output.....	56
6.12.8	Selecting the menu language.....	56
6.13	Entering the offset of the internal actual temperature (calibration).....	57
6.14	Restoring the factory calibration (internal temperature probe).....	57
6.15	Restore factory setting.....	58
6.16	Device status.....	59
6.16.1	Viewing the device status.....	59
6.16.2	Reading the Error store.....	59
6.16.3	Retrieving device data.....	60
6.16.4	Retrieving the software version.....	60
6.16.5	Displaying device type.....	60
6.16.6	Displaying serial numbers.....	61
6.17	Programmer.....	61
6.17.1	Program example.....	61
6.17.2	Selecting the program.....	64
6.17.3	Create and edit programs.....	64
6.17.4	Defining program loops.....	66
6.17.5	Starting, interrupting and ending a program.....	67
7	Maintenance.....	68
7.1	General safety instructions.....	68
7.2	Maintenance intervals.....	68
7.3	Cleaning the surfaces of the device.....	69
7.4	Checking the low-level protection.....	69
7.5	Cleaning the air-cooled condenser.....	70
7.6	Cleaning the water filter.....	70
7.7	Descaling the cooling water circuit.....	71
7.8	Check the heat transfer liquid.....	72
8	Faults.....	73
8.1	Alarms, errors and warnings.....	73
8.2	Alarm codes.....	73
8.3	Low level alarm.....	74
8.4	Overtemperature alarm.....	74
8.5	Warnings - control system.....	75
8.6	Warnings - safety system.....	76
8.7	Warnings - SmartCool.....	77

9	Decommissioning.....	79
9.1	Drain the device.....	79
9.2	Draining the condenser.....	79
10	Disposal.....	81
10.1	Disposing of refrigerant.....	81
10.2	Device disposal.....	81
10.3	Disposing of packaging.....	81
11	Technical data.....	82
11.1	General and type-specific data.....	82
11.2	Cooling output.....	84
11.3	Refrigerant and filling quantity.....	84
11.4	Filling volume and characteristics of the pumps.....	85
11.5	Heater.....	88
11.6	Potential equipment, voltage-independent.....	88
11.7	Mains fuse.....	89
12	Accessories.....	90
13	General.....	91
13.1	Copyright.....	91
13.2	Technical changes.....	91
13.3	Warranty conditions.....	91
13.4	Contact LAUDA.....	91
13.5	Declaration of Conformity.....	91
13.6	Product Returns and Clearance Declaration.....	93
14	Index.....	94

1 Safety

1.1 General safety instructions

- The devices can only be operated as intended under the conditions specified in this operating manual. Any other mode of operation is considered to be unintended use and could compromise the protection provided by the device.
- The devices are not designed for use in medical applications in accordance with DIN EN 60601-1 and IEC 601-1!
- This operating manual is part of the device. The information in this operating manual must therefore be kept at hand in the immediate vicinity of the device. Be sure to carefully store this copy of the operating manual.



If this operating manual is lost, contact LAUDA Service. You will find the contact information here ↪ Chapter 13.4 "Contact LAUDA" on page 91.

When operating the device, there is a risk of injury from high and low temperatures, and the presence of electrical energy. The risks posed by the device have been mitigated in the design to the extent possible, in keeping with the applicable norms. The remaining risk can be reduced using one of the following measures:

- If relevant, safety fittings are available for the device. This equipment is critical to the safety of the device. Appropriate maintenance activities must be implemented to ensure the device remains in good working order.
The safety fittings for the device are described in this "Safety" chapter.
- If relevant, various warning symbols are located on the device. These warning symbols must be followed at all times.
The warning symbols on the device are described in this "Safety" chapter.
- This operating manual contains safety information. These warning symbols must be followed at all times.
- Personnel and the protective equipment worn by personnel are also subject to specific requirements.
These requirements are described in this "Safety" chapter.



An overview of authorized personnel and protective equipment can be found in ↪ Chapter 1.14 "Personnel qualification" on page 11 and ↪ Chapter 1.15 "Personal protective equipment" on page 11.



Refer to ↪ Chapter 1.17 "Structure of warnings" on page 12 for more information on the general structure of warnings.

1.2 Obligations of the operator

The national regulations for operation applicable in the country in which the system is installed must be complied with.

In particular, the application of statutory regulations concerning operational safety must be observed.

Note the installation conditions outlined in ↪ Chapter 11.1 “General and type-specific data” on page 82.

Operators within the EU must meet the applicable provisions of Regulation (EU) No. 517/2014 on fluorinated greenhouse gases. The regulation provides a complete overview, and includes:

- The general purpose of the regulation is to reduce emissions of fluorinated greenhouse gases.
- Regular tightness checks, depending on the quantity of CO₂ equivalent (see type plate and regulation; regular tightness checks may be necessary if the CO₂ equivalent exceeds 5 t).
- Having leakage inspections, maintenance, repairs, decommissioning or recovery work carried out by certified, authorized personnel (for example LAUDA Service).
- Keeping records of refrigerants added or recovered, including quantity and type. Records must be kept for a minimum of 5 years.

1.3 Observing additional operating instructions

Interface modules

Additional interface modules can be fitted to the device. Before installing and using interface modules, always read and observe the operating manual accompanying the relevant interface module.

1.4 Intended Use

Intended Use

The present device is exclusively permitted to be used for tempering and delivering non-flammable heat transfer liquids in a closed circuit.

Non-intended use

The following applications are considered to be non-intended:

- in potentially explosive areas
- for tempering foodstuffs
- with a glass reactor without overpressure protection

1.5 Foreseeable misuse

Misuse of the device must always be prevented.

Among other things, the following uses are considered to be foreseeable misuse:

- Operation of the device without heat transfer liquid
- Incorrect connection of hoses
- Setting the device up on a tabletop surface
- Setting an incorrect pump pressure

1.6 EMC requirements

Table 1: Classification in accordance with EMC requirements

Device	Interference immunity	Emissions class	Customer power supply
Variocool	Type 2 in accordance with DIN EN 61326-1	Emissions Class B in accordance with CISPR 11	Only for EU Domestic connection value ≥ 100 A
Variocool	Type 2 in accordance with DIN EN 61326-1	Emissions Class B in accordance with CISPR 11	Rest of the world (outside EU) No limitation

Instructions for Class A digital device, USA

"This equipment has been tested and found to comply with the limits for Class A digital device, pursuant to Part 15 of the FCC (Federal Communication Commission) Rules. These limits are designed to provide reasonable protection against harmful interference when the equipment is operated in a commercial environment. This equipment generates, uses, and can radiate radio frequency energy and, if not installed and used in accordance with the instruction manual, may cause harmful interference to radio communications. Operation of this equipment in a residential area is likely to cause harmful interference in which case the user will be required to correct the interference at his own expense."

Instructions for Class A digital device, Canada

"This Class A digital apparatus complies with Canadian ICES-003" (ICES = Interference Causing Equipment Standards).

« Cet appareil numérique de la classe A est conforme à la norme NMB-003 du Canada ».

1.7 Software versions

These operating instructions are valid for devices using the following software versions onwards.

Software	valid from version
Command operating system	3.45
Control system	1.35
Analogue IO module	3.24
RS 232/485 module	3.22
Digital IO module	3.14
External temperature module	1.35
Ethernet module	1.23
EtherCAT module	1.06

1.8 Prohibition of modifications to the device

Any technical modification of the device by the user is prohibited. Any damage resulting from unauthorized modification is not covered by customer service or the product warranty. Service work may only be performed by the LAUDA Service department or a service partner authorized by LAUDA.

1.9 Fluorinated refrigerant

Refrigeration process thermostats are operated with fluorinated refrigerants. The designation and refrigerant charge are specified on the type plate.

1.10 Requirements for the heat transfer liquid

- Heat transfer liquids are used to control the temperature. LAUDA heat transfer liquids are recommended for the constant temperature equipment. LAUDA heat transfer liquids have been tested by the company LAUDA DR. R. WOBSEYER GMBH & CO. KG and approved for this device.
- The heat transfer liquids are suitable for a specific temperature range. This temperature range must correspond with the temperature range of your application.
- Hazards caused by high or low temperatures or fire may arise during operation if the heat transfer liquid exceeds or falls below certain temperatures or if the container ruptures causing a reaction with the heat transfer liquid.
- The safety data sheet of the heat transfer liquid specifies hazards and the corresponding safety measures required for handling the liquid. The safety data sheet of the heat transfer liquid must therefore be observed to ensure proper use of the device.
- If you wish to use your own heat transfer liquids, check to ensure that the fluids are compatible with the materials used.
- The heat transfer liquid must be provided with corrosion protection.

1.11 Materials

All parts that come into contact with heat transfer liquid are manufactured from high-quality materials adapted to withstand the operating temperature. High-quality stainless steels, copper, brass and premium-quality heat-resistant plastics are used.

1.12 Hose requirements

The hoses for the external hydraulic circuit must be resistant to:

- the heat transfer liquid used
- the pressure in the hydraulic circuit
- the high and low working temperatures

1.13 Application area

The device is exclusively permitted to be used in the following areas:

- Commercial sector
- Only used inside buildings
Outdoor installation is also possible with appropriate equipment.

- Ambient temperature range from 5 to 40 °C
Ambient temperature range with outdoor installation from -20 to 40 °C
- Maximum relative air humidity 80 % at temperatures up to 31 °C, linearly decreasing until 50 % relative air humidity at 40 °C
- Altitude up to a maximum of 2,000 m above sea level
- Mains voltage fluctuations up to $\pm 10\%$ of the rated voltage
- Surge category II
- Pollution degree 2
- Storage temperature range from 5 to 40 °C
- Transport temperature range from -20 to 43 °C

1.14 Personnel qualification

Operating personnel

Operating personnel are employees that have been instructed by technical staff in the intended use of the device according to the operating manual.

Specialized personnel

Certain activities on the device must be performed by specialized personnel. Specialized personnel are personnel whose education, knowledge, and experience qualify them to assess the function and risks associated with the device and its use.

1.15 Personal protective equipment



Protective gloves

Protective gloves must be worn for certain tasks. The protective gloves must comply with the standard DIN EN 374. The protective gloves must be chemically resistant.



Protective work clothing

Protective clothing must be worn for certain tasks. This protective clothing must meet the legal requirements for personal protective equipment. The protective clothing should be long-sleeved. Additionally safety shoes are required.



Safety glasses

Safety glasses must be worn for certain tasks. The safety glasses must comply with the standard DIN EN 166. The glasses must be tightly closed and equipped with side plates.

1.16 Product safety label

Hot



A "Hot surface" graphical symbol is affixed to the device. This symbol warns against hot surfaces on the device. These surfaces must not be touched during operation. These surfaces must be allowed to cool to room temperature before they can be touched during other operation phases such as servicing.

1.17 Structure of warnings

Warning signs	Type of danger
	Warning – danger zone.
Signal word	Meaning
DANGER!	This combination of symbol and signal word indicates an imminently dangerous situation that will result in death or serious injury if it is not avoided.
WARNING!	This combination of symbol and signal word indicates a potentially dangerous situation that can result in death or serious injury if it is not avoided.
CAUTION!	This combination of symbol and signal word indicates a possible dangerous situation that can result in minor injury if it is not avoided.
NOTICE!	This combination of symbol and signal word indicates a potentially dangerous situation that can result in material and environmental damage if it is not avoided.

2 Unpacking

DANGER!
 Transport damage

Electric shock

- Closely inspect the device for transport damage prior to commissioning!
- Never operate a device that has sustained transport damage!

Personnel: Operating personnel

1. Unpack the device.



Keep the original packaging of the device for subsequent transportation.

2. Check the device and accessories for completeness and transport damage immediately after delivery.



If the device or accessories are damaged contrary to expectations, immediately inform the shipping company so that a damage report can be compiled and the transport damage inspected. Also notify LAUDA Constant Temperature Equipment Service department immediately. You will find the contact information here ↪ Chapter 13.4 "Contact LAUDA" on page 91.

Table 2: Accessories included as standard

Device type	Designation	Quantity	Catalog number
VC 1200 (W) through VC 5000 (W)	Pump connection: 3/4" hose nozzle with 3/4" screw cap	2	EOA 004
VC 7000 (W) and VC 10000 (W)	Pump connection: 1" hose nozzle with 1 1/4" screw cap	2	EOA 003
Water-cooled devices	1/2" hose nozzle with 3/4" screw cap	2	EOA 001
All devices	Operating manual	1	--

3 Device description

3.1 Device types

The names of the devices consist of the following components.

Component	Description
VC	Variocool
<Number> e.g. 5000	Indication of the cooling capacity in kilowatts [kW] at 20 °C
W	Device with water cooling This indication in the device type denotes water- cooled devices.

- All devices are equipped with a bypass for regulation of the pump pressure.
- All devices are designed as floor-standing units. The devices are equipped with castors with locking brakes.

3.2 Setup of the device

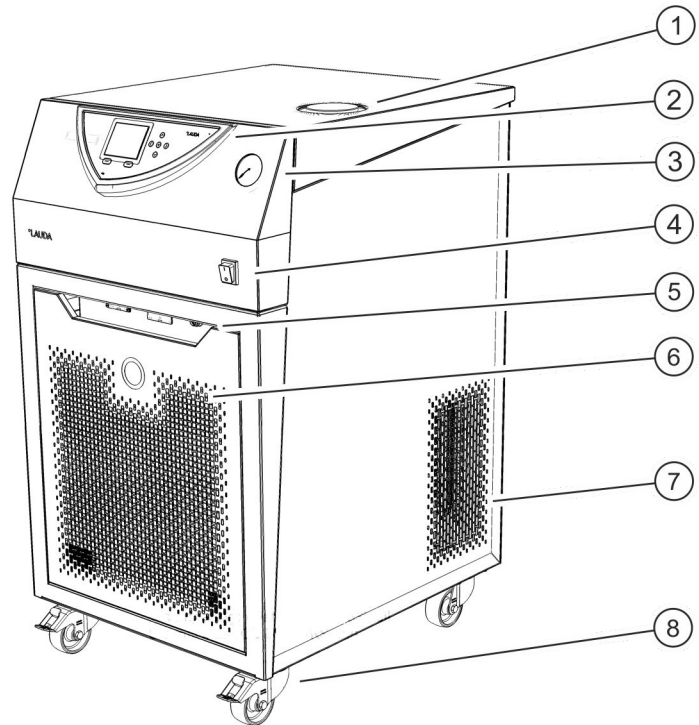

Fig. 1: Front of the VC 3000

- 1 Filler nozzle with cover
- 2 Control panel
- 3 Pressure gauge
- 4 Mains switch
- 5 Alarm output and module bays
- 6 Front panel (ventilation openings only in case of air-cooled devices)
- 7 Ventilation openings (on both sides)
- 8 Four castors (front castors with locking brake)

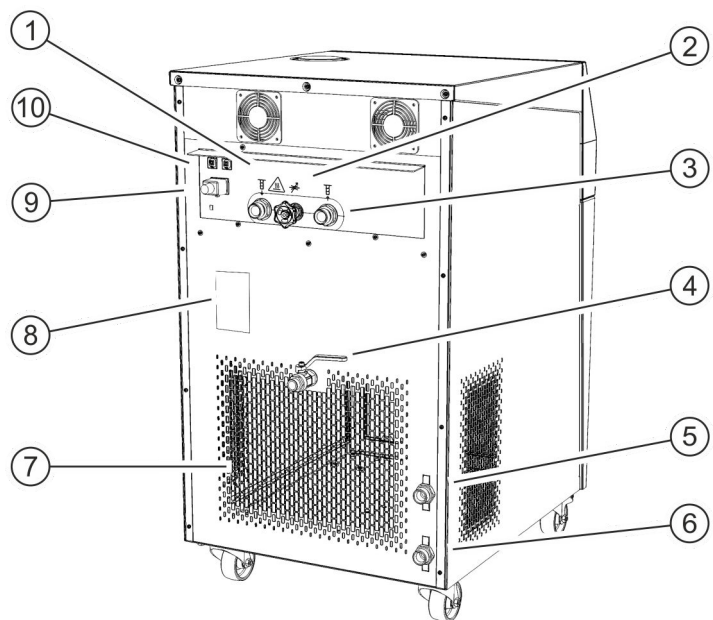

Fig. 2: Back of the VC 3000 W

- 1 Pump connection, outflow
- 2 Bypass adjusting wheel
- 3 Pump connection, return flow
- 4 Drain tap
- 5 Connecting sleeve for water cooling outlet (only available for water-cooled devices)
- 6 Connecting sleeve for water cooling intake (only available for water-cooled devices)
- 7 Ventilation grid
- 8 Rating label
- 9 Power supply
- 10 Fuses (up to and including VC 3000 (W))

Control panel

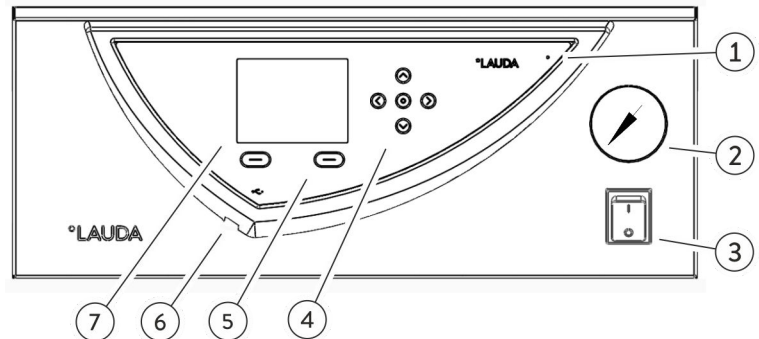

Fig. 3: Control panel

- 1 Light sensor
- 2 Pressure gauge
- 3 Mains switch
- 4 Entry key and arrow keys
- 5 Soft keys (left and right)
- 6 USB interface Type B (on the side of the control panel)
- 7 TFT display

3.3 Operating elements

3.3.1 Mains switch

VC 3000 (W) and lower

The mains switch can be toggled between the following positions:

- In position [I], the device is switched on.
- In position [O], the device is switched off.

VC 5000 (W) and higher

The mains switch can be turned to the following positions:

- In position [I], the device is switched on.
- In position [O], the device is switched off.

3.3.2 Display buttons

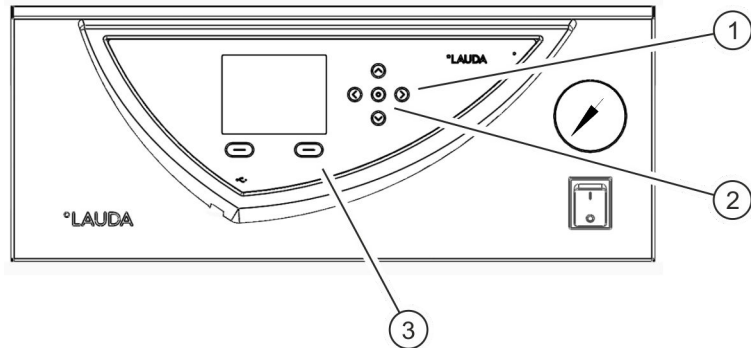

Fig. 4: Display buttons

- 1 Arrow buttons
- 2 Enter key
- 3 Soft keys

Functions in the device display can be controlled by means of the display buttons.

- The up, down, right and left arrow buttons can be used to navigate in the display.
- The Enter button can be used to confirm a selection in the display.
- The soft keys can be used to control the functions indicated on the display for these keys.

3.4 Functional elements

3.4.1 Hydraulic circuit



Fig. 5: Pressure gauge

The hydraulic circuit refers to the circuit that the heat transfer liquid flows through.

The circuit essentially consists of the following components:

- Internal expansion bath with heat transfer liquid
- Submersible pump for conveying the heat transfer liquid to the external consuming unit via the pump connections
- Adjustable bypass with pressure gauge for adjusting the pump pressure to the requirements of the external consuming unit.
- Cooling coil in the bath boiler for cooling the heat transfer liquid
- Heater in the bath boiler for heating the heat transfer liquid



You will find further information on the technical data for the pump in Chapter 11.4 “Filling volume and characteristics of the pumps” on page 85.

3.4.2 Cooling unit

The cooling unit consists of the following main components:

- Compressor
The compressor is equipped with a motor protection switch which reacts to the temperature and current consumption of the compressor.
- Condenser
An air-cooled or water-cooled condenser is used in the cooling unit depending on the device type. The heated air is discharged to the environment in air-cooled condensers. Fresh air is drawn in through the front of the device by means of a fan, heated and then discharged at the back of the device for this purpose. The heat is dissipated via the cooling water circuit in the case of water-cooled condensers.
- Evaporator
Heat is dissipated via a tube coil evaporator in the internal bath.



You will find technical data on the cooling unit in [Chapter 11.2](#) “Cooling output” on page 84.

3.4.3 Interfaces

A general overview of the standard interfaces and the optional interface modules of the device can be found in the following sections.



The equipment connected to the low-voltage inputs and low-voltage outputs must have safe separation from dangerous to touch voltages according to DIN EN 61140 such as by the use of double or reinforced insulation according to DIN EN 60730-1 or DIN 60950-1.



The installation of these additional interface modules is described in these operating instructions. Further information regarding wiring and the use of these interface modules is provided in the separate operating instructions for the interface modules. The respective operating instructions must be consulted regarding appropriate use.

USB interface

The devices are equipped with a USB interface (type B) as standard. This interface enables connection to a PC. Software updates are installed on the device via this interface (only for updaters, no process interface).

Alarm output

The devices are equipped with an alarm output as standard equipment. This changeover contact is switched if the device changes to the standby state or if an alarm is triggered. Reverse flow protection can be activated in this way or faults can be registered on a system.

Additional interface modules

Devices can be supplemented with additional interface modules.

- The **analog module** (catalogue number LRZ 912) has a 6-pin socket with two inputs and two outputs. The inputs and outputs can be configured as a 0 – 20 mA, 4 – 20 mA or 0 – 10 V interfaces independently of one another. A voltage of 20 V applied to the socket supplies power to an external sensor with electronic evaluation unit.
- The **RS 232/485 interface module** (catalogue number LRZ 913) is available in a 9-pin SUB-D socket design and is galvanically isolated by an optocoupler. The RS 232 interface can be connected directly to the PC using a 1:1 contacted cable. The LAUDA command set makes the interface module compatible with the product lines ECO, Variocool, Proline, Proline Kryomat, PRO, Integral XT and Integral T.
- The **contact module** (catalogue number LRZ 914) is available in a plug connector design according to NAMUR NE28. This contact module is identical to LRZ 915, but only has two sockets, each with one output and one input. The coupling socket (catalogue number EQD 047) and the coupling connector (catalogue number EQS 048) have a 3-pin design.
- The **contact module** (catalogue number LRZ 915) is available in a 15-pin SUB-D socket design. The module has 3 relay contact outputs (changeover contacts, maximum 30 V/0.2 A) and 3 binary inputs for control via external potential-free contacts.
- **Profibus module** (catalogue number LRZ 917). Profibus is a bus system used primarily in the chemical industry, which can connect a maximum of 256 devices at a high signal transmission rate.
- **Pt100-/LiBus module** (catalogue number LRZ 918). An external temperature probe can be connected to the Pt100 interface of the module. The Command remote control can be used with the constant temperature equipment via the LiBus interface. A solenoid valve for cooling water control, reverse flow protection or a Through-flow cooler can, for example be connected in this way.
- **LiBus module** (catalogue number LRZ 920). The Command remote control can be used with the constant temperature equipment via the LiBus connection. It is also possible to connect additional modules (such as the LRZ 918, but without Pt100 interface). A solenoid valve for cooling water control, reverse flow protection or a flow through cooler can, for example be connected in this way.
- **Ethernet USB module** (catalogue number LRZ 921). The module provides the customer with the opportunity to monitor and control thermostatic regulation processes that are performed with a LAUDA constant temperature equipment via Ethernet using the LAUDA interface command set.
An additional function of the module is remote maintenance of the LAUDA constant temperature equipment via Ethernet.
Currently, the USB interfaces of the module are not functional.
- **EtherCAT module** (catalogue number LRZ 922) with M8 connection sockets. **EtherCAT module** (catalogue number LRZ 923) with connection via RJ45 sockets. EtherCAT is an Ethernet-based field bus with master/slave functionality.

Refer to the operating manual accompanying the relevant LAUDA interface module for further information on connecting and using these interfaces.

3.5 Equipment

More powerful pump

A pump with a higher performance level can be installed in all devices. Depending on the pump power, this option reduces the cooling capacity by more than 200 W. The installation height of the device is also increased in the VC 1200 (W) and VC 2000 (W). A more powerful pump can only be installed at the factory.

Outdoor installation

Outdoor installation is possible for the air-cooled devices VC 5000, VC 7000 and VC 10000. The outdoor installation option can only be provided at the factory. The device may only be installed outdoors if it is protected from the effects of the weather (provide a shelter or enclosure).

Operation outdoors for outdoor temperatures below 5 °C:

- Outdoor installation has been configured. Displayed warning: **349 Device preheating XX min.**
The device shows this warning in the display after it has been switched on. The time remaining for preheating the compressor until it can be started is displayed. The compressor is preheated with its own heater. The other components (pump and heater) are started immediately after the device has been switched from Standby to operation.
- Outdoor installation has **not** been configured. Displayed warning: **349 Preheat device!**
The display shows this warning for 10 seconds after the device has been switched on. The device can then be started.



The compressor may suffer increased wear or material damage if it is not preheated!

Sound insulation

Sound insulation is possible for the devices VC 5000 (W), VC 7000 (W) and VC 10000 (W). Sound insulation can only be provided at the factory.

Insulation of the cooling water hydraulics

The cooling water hydraulics can be insulated in all water-cooled devices. The insulation can be provided at the factory or retrofitted on site by the LAUDA Service.

3.6 Type plate

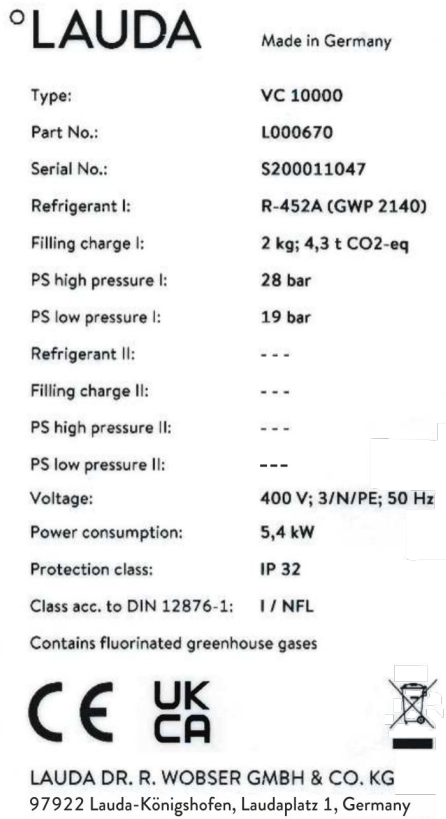

Fig. 6: Type plate (example)

The type plate information is explained in detail in the following table. Certain information is dependent on installed equipment.

Specification	Description
Type:	Device type
Part No.:	Catalog number of the device
Serial No.:	Serial number of the device
Refrigerant I:	Designation of the refrigerant used in the refrigerating machine, level 1
Filling charge I:	Filling charge of the refrigerant in the refrigerating machine, level 1
PS high pressure I:	Maximum permitted operating pressure at the refrigerant high-pressure side in the refrigerating machine, level 1
PS low pressure I:	Maximum permitted operating pressure at the refrigerant low-pressure side in the refrigerating machine, level 1
Refrigerant II:	Designation of the refrigerant used in the refrigerating machine, level 2
Filling charge II:	Filling charge of the refrigerant in the refrigerating machine, level 2
PS high pressure II:	Maximum permitted operating pressure at the refrigerant high-pressure side in the refrigerating machine, level 2
PS low pressure II:	Maximum permitted operating pressure at the refrigerant low-pressure side in the refrigerating machine, level 2
Voltage:	Device may only be operated with this distribution voltage and frequency
Power consumption:	Maximum power consumption of the device during operation
Protection class:	IP protection level of the device
Class according to DIN 12876-1:	German standard for electrical laboratory equipment

4 Before starting up

4.1 Installation

Special installation conditions apply to the devices. These installation conditions are specified for the most part in the technical data for the device.



You will find further information on the technical data in
 ↪ Chapter 11.1 “General and type-specific data” on page 82.

Additional installation conditions are described in the following.

- Irritant vapors may develop, depending on the heat transfer liquid and operating mode used. Always ensure that the vapors are adequately extracted.
- Note the electromagnetic compatibility (EMC) requirements of the device.
- Do not cover the ventilation openings.



You will find further information on the EMC requirements in
 ↪ Chapter 1.6 “EMC requirements” on page 9.



Operation outdoors for outdoor temperatures below 5 °C

A warning which states the preheating time of the compressor or that the compressor should be preheated is shown in the display. The compressor may suffer increased wear or material damage if it is not preheated! You will find further information in ↪ “Outdoor installation” on page 21.

Personnel: ■ Operating personnel



WARNING!
 Rolling away or overturning of the device due to incorrect handling

Impact, crushing

- Do not tilt the device.
- Position the device on an even, non-slip surface with a sufficient load carrying capacity.
- Actuate the castor brake when setting up the device.
- Do not place heavy parts on the device.

1. Place the devices on a suitable level surface.



The devices can be moved. To do this, release the locking brakes on the castors by pushing the lever upwards.

2. Lock the castors of the device. Press the lever down with your foot to lock.

4.2 Connecting the consumer



CAUTION!
Risk of external consumer bursting

Scalding, cold burns

- Adjust the pump pressure with the bypass.

4.2.1 Thermostatic hoses and hose clips



CAUTION!
Risk of heat transfer liquid escaping during operation caused by use of unsuitable hoses

Scalding, cold burns

- Use hoses with a temperature resistance that is appropriate for the operating temperature range of the device.
- Use hoses with a temperature resistance of at least 100 °C for devices with a heater.



CAUTION!
Contact with hot or cold hoses

Hot and cold burns

- Use insulated hoses for temperatures below 0 °C or above 70 °C.



The hoses specified below can be used for all heat transfer liquids that are approved for the devices.

Table 3: Hoses

Type	Device Pump connection	Accessories required (nipple and screw cap are provided on the device as standard)	Maximum operating pressure	Clear width x outer diameter in mm	Tem- perature range in °C	Catalogue number
EPDM hose with fabric reinforcement	VC 1200 to VC 5000 (W) G ¾ (15), nipple ¾"	Hose nozzle with screw cap EOA 004	10 bar	19 x 27	-40 – 100	RKJ 032
EPDM hose with fabric reinforcement	VC 7000 to VC 10000 (W) G 1¼ (20), nipple 1"	Hose nozzle with screw cap EOA 003	10 bar	25 x 34	-40 – 100	RKJ 033

Table 4: Hose clips

Suitable for hose	Clear width Ø in mm	Catalogue number
RKJ 112, RKJ 031	12 – 22	EZS 013
RKJ 032, RKJ 033	25 – 40	EZS 016

4.2.2 Connecting an external consuming unit



CAUTION!
Risk of heat transfer liquid escaping during operation due to open consuming unit

Electric shock, scalding, cold burns

- Always use hydraulically sealed consuming units.



CAUTION!
Risk of external hydraulic circuit bursting due to overpressure

Scalding, cold burns

- When laying the hoses, make sure they cannot kink.

Please note the following:

- To prevent damage to the consuming unit, open the bypass adjusting wheel on the back of the device to the full extent before switching on. Turn the wheel counterclockwise to do this.
- Temperature control hoses: Always use the largest possible diameters and shortest possible hoses in the external circuit.
If the temperature control hose diameter is too narrow, the insufficient flow rate will cause a drop in temperature between the device and the external consuming unit. In this case, increase or decrease the temperature accordingly.
- Secure the temperature control hoses using hose clips.
- When external consuming units are positioned higher than the device, the external volume may run dry when the pump is switched off and air enters the external fluid circuit, even when the circuits are closed. There is then a danger that the device will overflow.
- If a hose breaks hot liquids may leak out, thus endangering people and materials.

4.3 Cooling water

4.3.1 Cooling water requirements

This section is relevant for:

- Water-cooled devices

	NOTICE! Risk of cooling circuit leaking due to corrosion
	Device damage
	<ul style="list-style-type: none">● Do not use corrosive cooling water.

Requirements

Cooling water is subject to specific purity requirements. A suitable procedure must be employed to purify the cooling water in line with the contamination in the water and maintain the water quality. Unsuitable cooling water may cause the condenser and the entire cooling water circuit to become blocked or damaged, or start to leak. The entire cooling circuit and cooling water circuit may sustain extensive consequential damage as a result.

- Free chlorine consisting of disinfectant, for example, and water containing chloride will cause pitting corrosion in the cooling water circuit.
- Distilled, deionized and demineralized water are unsuitable due to their reactivity and will cause corrosion in the cooling water circuit.
- Sea water is unsuitable due to its corrosive properties and will cause corrosion in the cooling water circuit.
- Iron particles and water containing iron will cause corrosion in the cooling water circuit.

- Hard water is unsuitable for cooling due to the high lime content and will lead to calcification of the cooling water circuit.
- Cooling water containing suspended matter is unsuitable.
- Untreated, unpurified water such as river water or cooling tower water is unsuitable due to its microbiological content (bacteria), which can settle inside the cooling water circuit.

Suitable cooling water quality

Data	Value	Unit
pH value	7.5 – 9.0	---
Hydrocarbonate [HCO_3^-]	70 – 300	mg/L
Chloride	< 50	mg/L
Sulfate [SO_4^{2-}]	< 70	mg/L
Ratio hydrogen carbonate [HCO_3^-] / sulfate [SO_4^{2-}]	> 1	---
Total water hardness	4.0 – 8.5	°dH
Electrical conductivity	30 – 500	$\mu\text{S}/\text{cm}$
Sulfite (SO_3^{2-})	< 1	mg/L
Free chlorine gas (Cl_2)	< 0.5	mg/L
Nitrate (NO_3^-)	< 100	mg/L
Ammonia (NH_3)	Not permitted	---
Iron (Fe), dissolved	< 0.2	mg/L
Manganese (Mn), dissolved	< 0.05	mg/L
Aluminum (Al), dissolved	< 0.2	mg/L
Free aggressive carbon dioxide (CO_2)	Not permitted	---
Hydrogen sulfide (H_2S)	Not permitted	---
Algae growth	Not permitted	---
Suspended matter	Not permitted	---

4.3.2 Connecting the cooling water

Specification	Value
Maximum cooling water pressure	10 bar
Differential pressure cooling water Δp	1 – 6 bar VC 1200 W and VC 2000 W 3 – 6 bar VC 3000 W and higher
Cooling water temperature	approx. 15 °C recommended, 10 – 30 °C permitted (in upper range with performance restrictions)

Note the following:

- Secure the cooling water hoses in place on the device using hose clips.
- Secure the cooling water return hose in the outlet area to prevent the hose from jerking suddenly, even when pressure surges occur.
Secure the water cooling return hose in the outlet area in such a way that hot cooling water cannot spray out.
- Avoid kinking or crushing the hoses.
- We recommend using a leakage water detector with water shut-off function to prevent leakages from causing damage in the cooling water system.
- Only use cooling water that meets the quality requirements.
- If the condenser leaks, there is a danger that refrigerating machine oil and refrigerant from the device's refrigerant circuit will mix with the cooling water. Observe the legal requirements and provisions of the water supply company applicable at the operation site.

4.4 Interfaces

4.4.1 Interface potential-free contact

- The contacts may be loaded with a maximum voltage of 30 V direct current (DC) and a maximum current of 0.2 A.

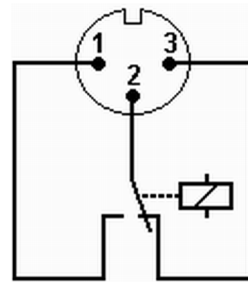

Fig. 7: Flange plug (front) in fault condition

View of the flange plug (front) or into the coupling socket on the soldering side.

Good condition

- Pin 1 and 2 are closed.
- During trouble-free operation, the alarm output is in good state.

Fault condition

- Pin 2 and 3 are closed.
- The alarm output is in fault condition:
 - If the device is switched off,
 - after switching on, if a fault (e.g. low level) is already present,
 - during operation, if a fault occurs, and
 - for each event configured in the *Alarm Output* menu.



You can find information on the settings for the alarm output in Chapter 6.12.7 "Setting the alarm output" on page 56.

Please note the following:

- The equipment connected to the extra-low voltage inputs and outputs must be reliably isolated from voltages dangerous to the touch in accordance with DIN EN 61140. For example, by double or reinforced insulation according to DIN EN 60730-1 or DIN 60950-1.
- Only use protected connection lines. Connect the protective screen with the connector shell. Cover unused connectors with protective caps.

4.4.2 Installing modules

Optional interface modules can be installed in the devices. They can be installed in two module bays of different sizes located on the front of the device.

- Right module bay (approx. 51 mm x 27 mm) for RS 232/485 module/ analog module/contacts/profibus module
- Left module bay (approx. 51 mm x 17 mm) for Pt100/LiBus module

This section is relevant for the following cases, for example:

- You want to use an external temperature probe.
- You want to transfer a signal, such as the actual temperature, from an external consumer to the constant temperature equipment.
- You want to transfer a signal, such as the set temperature, to an external device.
- You want to use the Command remote control.



DANGER!
Contact with live parts

Electric shock

- Disconnect the device from the mains power supply before installing modules.

1. Touch the grounded bare stainless steel back of the circulation chiller in order to discharge any possible electrostatic charge.
2. Remove the module from its packaging.
3. Turn off the constant temperature equipment and pull out the mains plug.
4. The module bays are protected with a cover. Loosen the screws for the cover of the corresponding module bay and carefully remove the cover.
5. Carefully remove the bus connection cable from the cover.
6. Insert the bus connection cable – red plug into red socket.



The plug and the socket are reverse polarity protected.

7. Insert the module into the corresponding bay and fasten it with the two cross-head screws.

5 Commissioning

5.1 Heat transfer liquids

Note:

- The heat transfer liquids each cover a recommended temperature range and must be suitable for the temperature range of your application.
- At the lower limit of the temperature range, the heat transfer liquid becomes more viscous and influences temperature stability, pump power and cooling capacity. The formation of vapours and odours increases in the upper range. Therefore, only use all of the temperature range if required. Particularly with Aqua 90 (water), ice forms which can result in destruction of the device.
- Never use contaminated or degenerated heat transfer liquid.
- Observe the safety data sheet of the heat transfer liquid. You can request the safety data sheets of the heat transfer liquid at any time if required.

Table 5: Approved heat transfer liquids

LAUDA designation	Chemical designation	Temperature range in °C	Viscosity (kin) in mm ² /s (at 20 °C)	Viscosity (kin) in mm ² /s for temperature	Container size		
					Catalogue number		
					5 L	10 L	20 L
Kryo 30	Monoethylene glycol / water mixture	-30 – 90	4	50 at -25 °C	LZB 109	LZB 209	LZB 309
Aqua 90	decalcified water	5 – 90	1	---	LZB 120	LZB 220	LZB 320

Note the following for Kryo 30:

- The water content is reduced during long operating at higher temperatures and the mixture becomes flammable (flash point 119 °C). Check the mixture ratio using a hydrometer.

Heat transfer liquid water

- The alkaline earth ions content (hardness) of the water must be between 0.71 mmol/L and 1.42 mmol/L (equivalent to 4.0 and 8.0 °dH). Harder water results in lime deposits in the device.
- The pH value of the water must be between 6.0 and 8.5.
- Distilled, deionised, demineralised (DM) water or seawater must not be used due to their corrosive properties. Ultra-pure water and distillates are suitable as a medium after addition of 0.1 g soda (Na₂CO₃, sodium carbonate) per litre of water.
- Any chlorine content in the water must be strictly avoided. Do not add any chlorine to the water. Chlorine is contained, for example, in cleaning agents and disinfectants.
- The water must be free of impurities. Water containing iron is unsuitable due to rust formation and untreated river water is unsuitable due to algae formation.
- The addition of ammonia is not permitted.

5.2 Establishing power supply

Personnel: Operating personnel

	NOTICE! Use of impermissible mains voltage or mains frequency
	Device damage <ul style="list-style-type: none"> ● Compare the rating label with the available mains voltage and mains frequency.

Note the following:

- Only connect the device to sockets with a protective earth conductor (PE).

Note for electric installation on site:

- Single-phase devices
 - Single-phase devices must be fused with a circuit breaker of max. 16 amperes.
 - Exception: Devices with 13 ampere UK plugs.
- Three-phase devices
 - Three-phase devices must be fused according to the power consumption. The value can be found on the type plate. Always select the fuse that is immediately higher. The use of an excessively high fuse is not permitted.

Pump with three-phase motor

Personnel: Specialized personnel

The pump of the device types VC 5000 (W), VC 7000 (W) and VC 10000 (W) is driven by a three-phase motor. The direction of rotation of the power supply must be considered. The direction of rotation of the three-phase connection must be reversed by swapping 2 phases if the pressure gauge shows no pressure build-up!

	<i>This should only be performed by an electrician!</i>
---	---

5.3 Switching on the device for the first time and filling with liquid

5.3.1 Fill mode

	<i>If the filling mode is active, the words "filling mode" appear on a yellow background in the basic window. The device does not heat or does not cool.</i>
---	--

The device has a program for convenient filling with heat transfer liquid.

If the fill level of the device is too low, i.e. at level stage 0, the *Fill mode* is started immediately after switching on the device. The fill mode supports the correct filling of the device. The current level stage is displayed under *Start filling* (in the menu *Setup* → *Fill mode*).

An audible signal with long intervals is output from approx. the fourth level stage to warn about any overfilling of the device. If filling continues, the interval of the signal is shortened in the following level stage. You must end the filling at the latest now.

If a continuous tone sounds, the device is overfilled and cannot be started. You must drain some heat transfer liquid from the device to be able to start it again.

To fill an external consumer, press the *Standby* softkey when there is sufficient fill level to start the pump. The heat transfer liquid now pumped into the external consumer can be refilled immediately. If the fill level drops too far, the device automatically goes into the standby state and the pump is switched off. This process is performed until the device and the connected consumer are filled.

The fill mode is completed with *End filling* and the audible notifications are deactivated. The fault messages for low level and high level take effect again.



After ending the filling mode, the device starts the temperature control thermostating, provided the starting state is not set to *off*. Changing the starting mode can be found in ↪ Chapter 6.12.4 “Specifying the starting mode (Auto start)” on page 54.

5.3.2 Switch on the device and fill it

- Personnel: ■ Operating personnel
- Protective equipment: ■ Safety glasses
 ■ Protective work clothing
 ■ Protective gloves



WARNING!
 Overflow of heat transfer liquid

Electric shock

- Do not overfill the device. Observe the level display and the thermal volume expansion of the heat transfer liquid.



WARNING!
 Spraying of heat transfer liquid

Electric shock

- Do not spray heat transfer liquid. Use a funnel for filling.

- Close the drain tap. Turn the lever to the left to do this.
- Switch on the device at the mains switch. A signal tone is emitted.



Press the mains switch to Position [1] in the devices VC 3000 (W) and lower.

Turn the mains switch to Position [1] in VC 5000 (W) and higher.

- ▶ The menu for selecting the language then appears.



Fig. 8: Start screen



Fig. 9: Selecting the menu language

- The window for selecting the menu language is shown on the display. Use the up and down arrow buttons to select the desired [language]. Press the Enter button to confirm your selection.



For example, select [Deutsch] to see display entries in German.

You can change the menu language at any time via the menu.

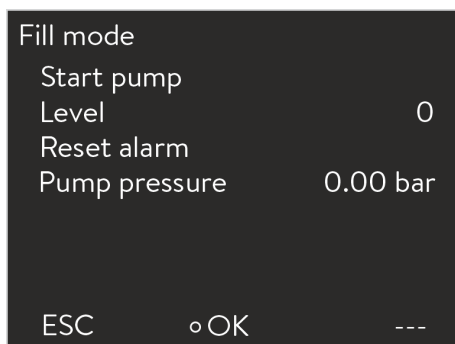

Fig. 10: Fill mode

4. The device detects low or empty level of the heat transfer liquid.
 - ▶ The device automatically starts the fill mode.
5. Pull off the cover of the filler nozzle by lifting it upwards.
6. Fill the device with heat transfer liquid. Observe the display and pay attention to the acoustic signals of the device when doing so.



Use a funnel for filling if required.

The fill mode can be called again at any time via the menu.

7. Close the filler nozzle with the cover.
8. End the fill mode by selecting and confirming [End filling].



After the fill mode has been ended, the device starts the temperature control unless the starting mode is set to [off].

You will find out how to change the starting mode in Chapter 6.12.4 “Specifying the starting mode (Auto start)” on page 54.

9. The Home window appears.



You cannot start the device until you end the Fill mode.



Operation outdoors for outdoor temperatures below 5 °C

A warning which states the preheating time of the compressor or that the compressor should be preheated is shown in the display. The compressor may suffer increased wear or material damage if it is not preheated! You will find further information in “Outdoor installation” on page 21.

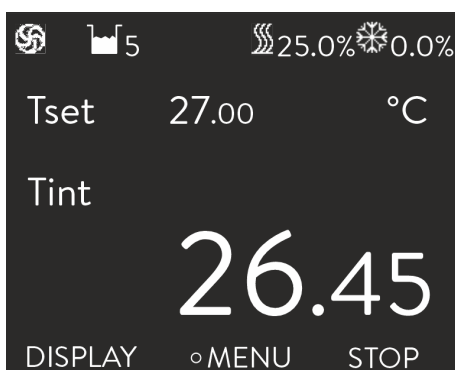

Fig. 11: Home window

5.4 Setting the pump pressure

The pump pressure can be set for devices with a bypass via a control valve on the back of the device. The pump pressure can therefore be set individually for pressure-sensitive external consuming units.

Open the bypass adjusting wheel on the back of the device to the full extent before switching the device on. Turn the wheel counterclockwise to do this.

Personnel: Operating personnel



CAUTION!
Bursting of external consuming unit due to excess pressure

Scalding, frostbite, cuts

- If using a pressure-sensitive consuming unit (such as a glass reactor), use a pressure relief device.



CAUTION!
Bursting of the external application due to overpressure

Scalding, frostbite, impacts

- For applications with a maximum permissible working pressure that is less than the maximum pressure of the pump, use a pressure relief device for protection. This pressure relief device must be installed in the outflow to the application.
- Set the maximum pump pressure as per your application.

1. To increase the pressure in the consuming unit, turn the bypass adjusting wheel clockwise until the maximum permissible pressure for the external consuming unit is reached.



Monitor the pressure indication on the front of the device when doing this.

6 Operation

6.1 General safety instructions



CAUTION!
Risk of external consumer bursting

Scalding, cold burns

- Adjust the pump pressure with the bypass.



CAUTION!
Overheating beyond maximum operating temperature in the event of a fault

Burns, scalding

- In the event of a fault, devices with a heater may reach temperatures of up to 100 °C.

6.2 Operating modes

Two operating modes are supported for the devices.

- During operation, the components of the device are operated.
- In the standby operating mode, all components of the device are switched off. Only the display of the device is supplied with power. For example, this operating mode is suitable for making extensive settings.

6.3 Menu structure overview

Menu structure for Setpoint Value, Setup and Programmer

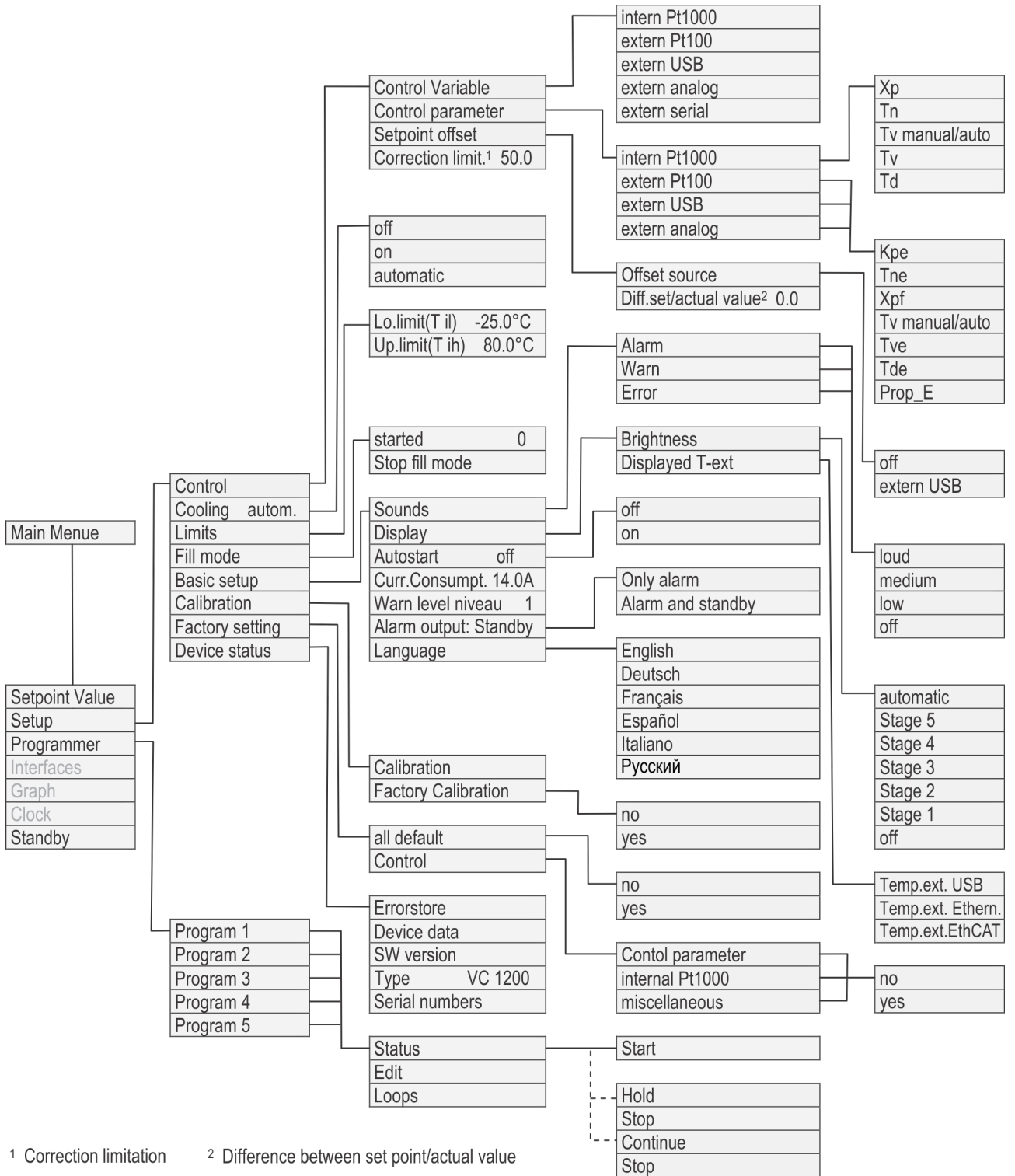

¹ Correction limitation ² Difference between set point/actual value

Fig. 12: Menu structure part 1

Menu structure for Graph, Clock and Standby

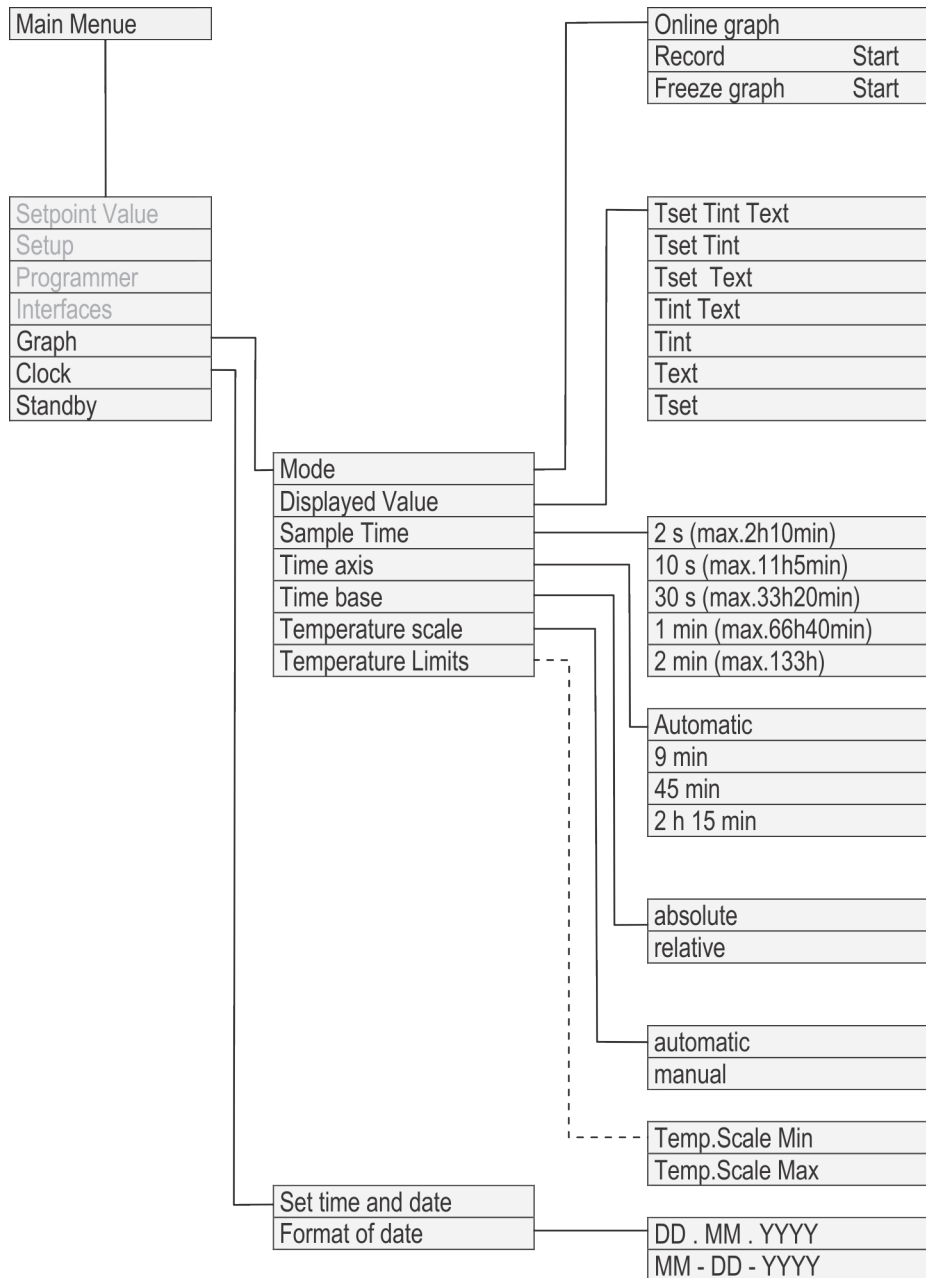

Fig. 13: Menu structure part 2

6.4 Switching on the device

Personnel: Operating personnel

1. Switch on the device at the mains switch.



You will find further information about switching on the device in [Chapter 5.3.2](#) “Switch on the device and fill it” on page 33.

- ▶ A signal tone is emitted.

2. The Home window appears.



After the device has been switched on, it is in Standby mode by default (soft key shows [START]) unless the starting mode has been set to on. You will find out how to change the starting mode in [Chapter 6.12.4](#) “Specifying the starting mode (Auto start)” on page 54.

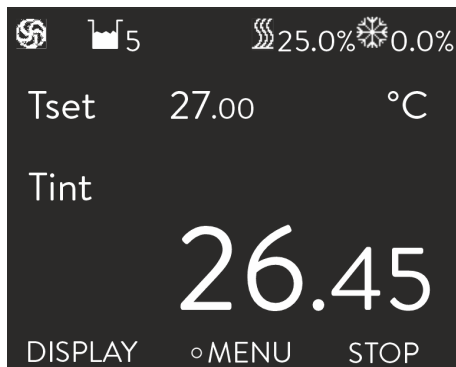

Fig. 14: Home window

6.5 The display

6.5.1 Home window

The Home window is displayed after the device has been switched on. The appearance of the Home window is changed by pressing the [DISPLAY] softkey.

During normal operation

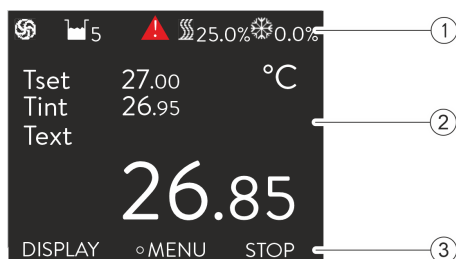

- 1 Overlaid status display
- 2 Display of the temperatures (device regulates to the control variable external T_{ext})
- 3 Soft key bar

Fig. 15: Home window

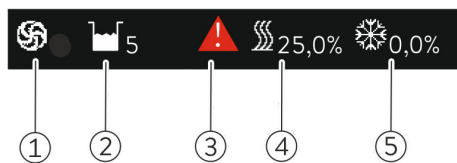

Fig. 16: Status display

- 1 The pump symbol rotates when the pump is running.
- 2 Level indication
- 3 A warning is displayed
- 4 The heater is active and heats with the displayed percentage of total power.
- 5 Cooling is active and cools with the displayed percentage of total cooling capacity.

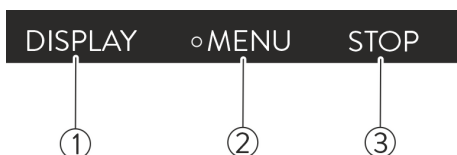

Fig. 17: Soft key bar

- 1 Left softkey
- 2 Enter button
- 3 Right softkey

The functions of the soft keys and the function of the Enter button are shown in this bar.

In the Standby mode

The button assignment [START] is displayed in the soft key bar in Standby mode instead of the button assignment [STOP]

6.5.2 Menu window

Navigating to the main menu

1. You can perform the following steps to bring up the main menu:
 - Press the Enter button in the Home window.
 - If you are in a sub-menu, you can return to the Home window by pressing the left arrow button.

Structure of the main menu

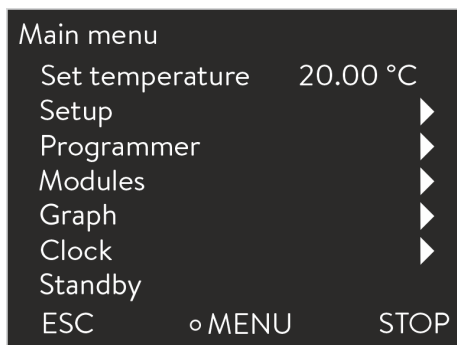

Fig. 18: Main menu

The main menu and the sub-menus consist of menu items which are marked as follows.

Symbol	Description
▶	Indicates that other menu levels (sub-menus) are available.
🔒	The padlock symbolizes a blocked function. These functions cannot be customized.

The currently selected entry is marked.

Structure of sub-menus

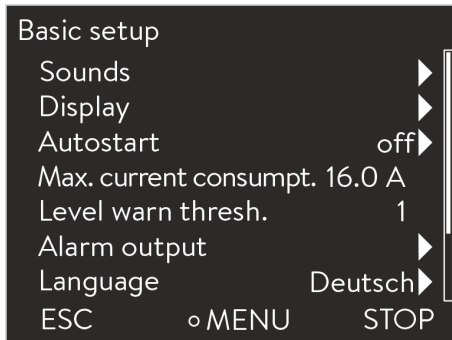

Fig. 19: Sub-menu

The structure of sub-menus basically corresponds to that of the main menu.

Functionality of the soft key bar

The soft key bar is shown at the bottom of the display. The soft keys can be used to select e.g. the following functions:

The [ESC] soft key takes you back to the Home window.

The [STOP] soft key puts the device into Standby mode.

Functionality of the Enter button

The [OK] input button brings up a sub-menu or an entry window.

Navigation in the menus

- The following options are available:
 - Use the up and down arrow buttons to navigate between the menu items.
 - Press the right arrow button to select a sub-menu.
 - Press the left arrow button to return to a previous menu.
 - The selected menu option is marked.

6.5.3 Entry window

Settings in the display are configured via the entry window. Two varieties of entry windows are available.

Entry window for selecting options

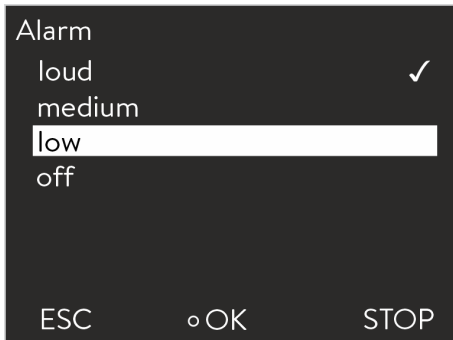

Fig. 20: Selecting options

- The check mark indicates the active function.
- The arrow buttons are used to navigate in the options.
- The selected setting is marked in the process.
- Press the [ESC] soft key to return to the previous display without making any changes.
- Press the [OK] input button to accept the selected setting.

Entry window for manual input



Fig. 21: Entering values

- The value to be entered is displayed in enlarged font. The cursor flashes under the value.
- You can also select individual numeric characters and change them by pressing the left and right arrow button.
- You can change the value with the up and down arrow buttons. If you keep one of the two arrow keys pressed down longer, the change will be accelerated.
- You can change the sign with the [+/-] soft key if the appropriate equipment is installed on your device.
- *Min:* and *Max:* indicate the limits of the entered value.
- Press the [OK] input button to accept the set value.
- Press the [ESC] soft key to return to the previous display without making any changes.

6.5.4 Lock and release operating buttons

The operating buttons can be locked in order to protect the device when using a process control system or against unauthorized access.

Lock operating buttons

Personnel: Operating personnel

1. Change to the main menu.
2. Press and hold down the [ENTER] button.
3. Press and hold down the [Down] arrow button within 4 seconds.
4. Hold down both buttons for 4 seconds.
 - ▶ In the display the descriptions of the buttons are replaced by [---].
 - The entry function is now locked.



The display can be switched between basic window and graphic display.

Release operating buttons

Personnel: Operating personnel

1. Press and hold down the [ENTER] button.
2. Press and hold down the [Up] arrow button within 4 seconds.
3. Hold down both buttons for 4 seconds.
 - ▶ In the display the descriptions of the buttons show up again.
The device can be operated again.

6.6 Define temperature limits

You can use the temperature limits to specify the temperature range of your application, i.e. the temperature range in which temperature control can take place.

Personnel: Operating personnel

1. Switch to the main menu.
2. Select the menu item *Setup* → *Temp. limits*.
3. Select one of the following options:
 - Select the first entry *Til* to set the lower limit value.
 - Select the second entry *Tih* to set the upper limit value.

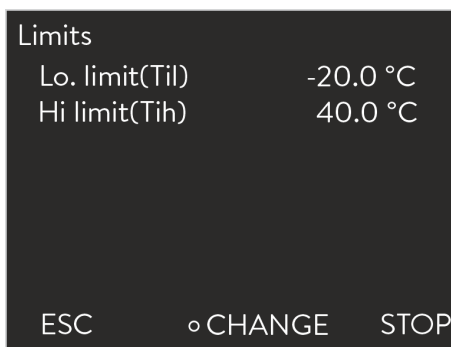

Fig. 22: Selecting the temperature limit

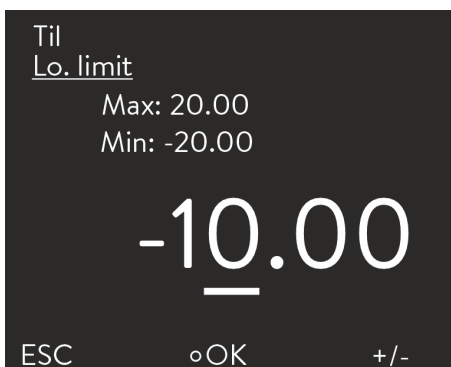

Fig. 23: Defining temperature limits

4. Customize the value in the following entry window.

6.7 Specifying the set point

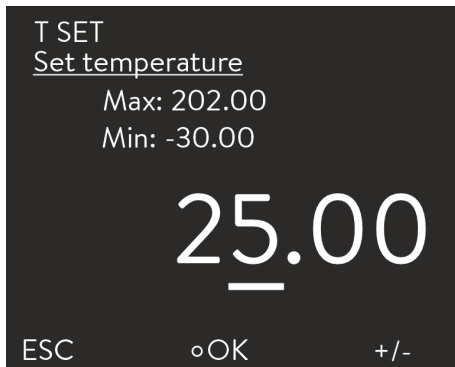

Fig. 24: Specifying the set temperature

Personnel: Operating personnel

1. Switch to the main menu.
2. Select the menu item *Set temperature* in the main menu.
 - ▶ An entry window appears. The cursor blinks under the value. The set temperature can be set to a value within the limits displayed.
3. Customize the set temperature accordingly.
4. Press the input button to confirm.

6.8 Activating and deactivating standby

In standby mode, device components such as the pump are switched off. The display remains active.

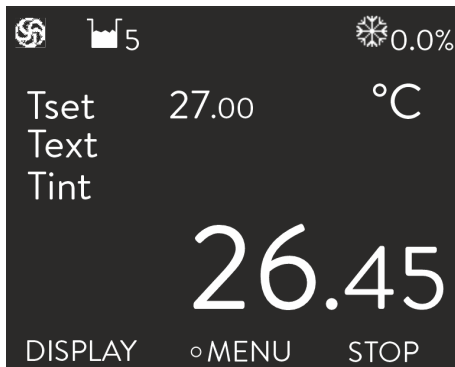

Fig. 25: Device in operation

Personnel: Operating personnel

1. Press the [STOP] soft key.
 - ▶ The device is now in Standby mode.
2. Press the [START] soft key to activate the Operation mode.

6.9 SmartCool (cooling)

The cooling unit of the constant temperature equipment is operated in the default [autom.] setting. Depending on the temperature and operating status, the cooling unit is automatically switched on or off. You can also manually switch the cooling unit on or off via the menu.

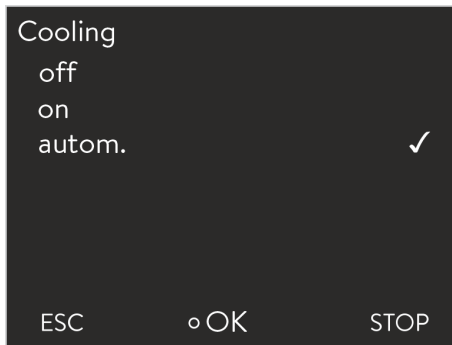

Fig. 26: Setting the cooling

1. Switch to the main menu.
2. Select the menu item *Setup* → *Cooling*.
3. Select one of the following options:
 - With the [autom.] setting, the cooling unit is switched automatically. When cooling capacity is required, the cooling unit switches on.
 - With [off], the cooling unit always remains switched off.
 - With [on], the cooling unit is always switched on, even if no cooling capacity is required.
4. Press the input button to confirm.

6.10 External control

6.10.1 Activating the external control

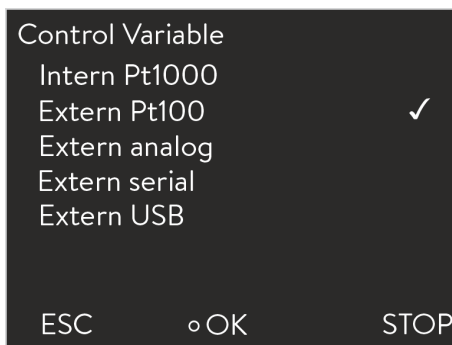

Fig. 27: Activating the external control

Personnel: Operating personnel

1. Select the menu item *Control Variable* → *extern Pt100* in the Control menu.



This option is only available if a Pt100 module for an external temperature probe has been connected. A Pt100 temperature sensor must be connected to the module.

2. Press the input button to confirm.

6.10.2 Specifying the set point offset

A value can be applied to the temperature specified by the external temperature probe and then processed as a set point. The bath temperature can therefore be set e.g. to -15 °C below the temperature of a reactor which is measured by the external temperature probe.

Navigating to the settings

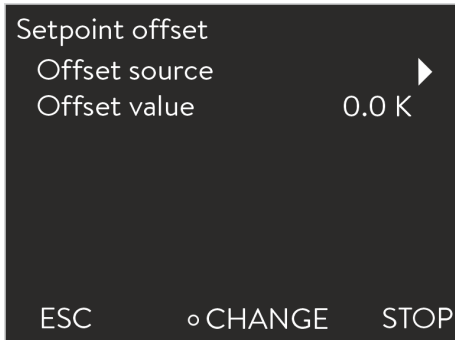

Fig. 28: Set point offset menu

Selecting the offset source

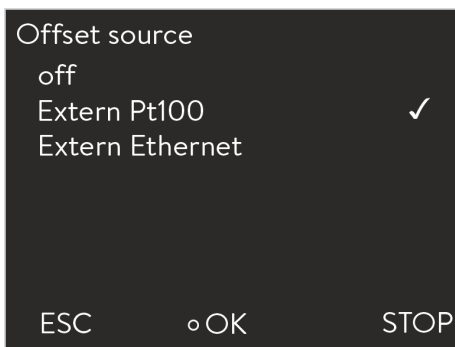

Fig. 29: Selecting the offset source

Specifying the offset



Fig. 30: Specifying the offset value

6.11 Control

Personnel: Operating personnel

1. Switch to the main menu.
2. Select the *Setup* → *Control* → *Set point offset* menu item.
3. Select one of the following options:
 - *Offset source* allows you to select the source used to measure the offset.
 - *Offset value* allows you to enter the value of the offset.

Personnel: Operating personnel

1. Select the menu item *Offset source* in the set point offset menu.
2. Select one of the following options:
 - You deactivate the set point offset with *off*.
 - You can select the appropriate source with the other menu items. For example, you can specify the set point offset via an external temperature probe with *extern Pt100*.



Press the left arrow button to return to the previous display without making any changes.

3. Press the input button to confirm.

Personnel: Operating personnel

1. Select the menu item *Offset value* in the set point offset menu.
 - ▶ An entry window appears.
2. Adjust the offset value within the displayed limit values.
3. Press the input button to confirm.

The internal and external control parameters are preset for operation with water as the heat transfer liquid at the factory. It may be necessary to adjust the control parameters on a case-by-case basis, depending on the application. The specific thermal capacity and viscosity of the heat transfer liquid also influence the control action, and the control parameters may need adjusting as a result.

6.11.1 Basics

Explanation of terms

Control value	- Output value of the controller to compensate for the difference of actual value to setpoint (control deviation).
PID controller	- The PID controller operates very precisely and consists of P, I and D parts.
Proportional range X_p	- The proportional range X_p specifies the temperature range in which the proportional part (P part) of the controller is 0 – 100 % of the maximum control value. For example, if the control deviation is 2 K for X_p set to 10 K, the P part is 20 % of the control deviation. In the case of a control deviation of 10 K and more, the P part is 100 % of the control value.
Reset time T_n	- The reset time is decisive for the integral part (I part) of the control value. It specifies the interval in which an existing control deviation is integrated. The larger T_n is, the slower the control deviation is integrated. Thus, the control is slower. A smaller T_n makes the control more dynamic and finally results in oscillations.
Lead time T_v	- The differential part (D part) of the control value is formed from the lead time T_v . It influences the approach speed of the actual value to the setpoint and counteracts the P and I parts. The larger the lead time T_v is set, the stronger the output signal is damped. As rule of thumb, the following applies: $T_v = T_n \times 0.75$.

Optimising the hydraulic system

An important prerequisite for acceptable control quality is a well designed hydraulic system. Therefore, an as good as possible connection between the application to be temperature-controlled and the constant temperature equipment must be established. This means:

- Only use approved heat transfer liquids: water or water-glycol mixture.
- Use short tubes with large cross section. This reduces the flow resistance. A lot of heat transfer liquid can circulate in a short time, thus the circulation time is short.
- Use bypass of the device to increase the flow rate of the heat transfer liquid.

Other precautions

The viscosity of the heat transfer liquid changes very quickly with the temperature. The liquids have higher viscosity at low temperatures. Therefore, the control quality is generally worse at low temperatures. For this reason, the controller should be set at the lower end of the temperature range to be covered. If the control is stable at low temperatures, then it is generally also stable at high temperatures. On the other hand, if a system is just still stable at high temperatures, it is highly probable it will be unstable at low temperatures, i.e. it oscillates.



If, for example, the operating temperature range of a system is -20 – 80 °C, then the controller setting should take place at -10 – 20 °C.

Indications of incorrect settings

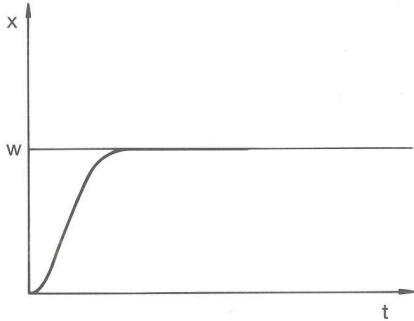

Fig. 31: Optimum setting

The picture on the left shows optimum setting of the control parameters.

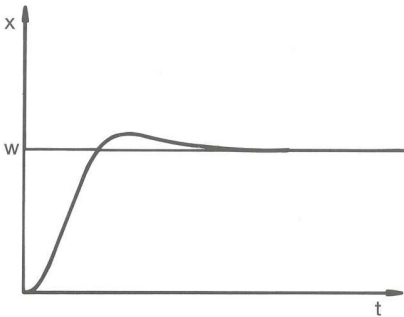

Fig. 32: Control parameter X_p too large

If the X_p parameter is selected too large, the actual value reaches the proportional range early and the P part becomes smaller than 100 % of the control value. The approach to the setpoint slows down. Thus, the simultaneously integrating I part has more time to build up its control value portion. If the setpoint is reached, the I part summed too much results in overshooting beyond the setpoint. If the proportional range X_p is reduced, the P part remains at 100 % for longer. Therefore the actual value approaches the setpoint more quickly and the I part has less time to integrate the control difference. The overshooting is reduced.

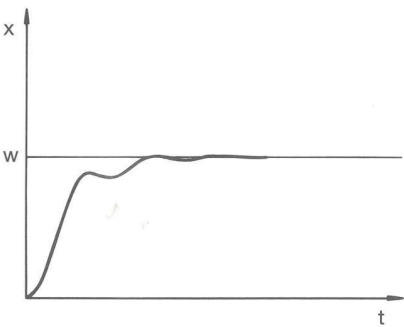

Fig. 33: Control parameter X_p too small

If the proportional range selected is too small, the P part on the control value is at 100 % for a very long time. This value then reduces more quickly within the proportional range, i.e. the control value reduces rapidly and the approach of the actual value to the setpoint almost comes to a standstill. Due to the I part not becoming effective until now, the actual value approaches the setpoint slowly.

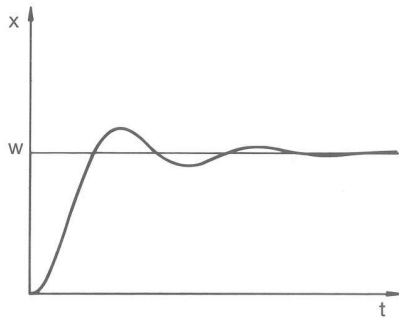

Fig. 34: Control parameters T_n and T_v too small

In this case shown, the I part is set too large (parameter T_n too small). The I part integrates the control deviation until this becomes 0. If this integration runs too quickly, the control value, i.e. the output signal of the controller, is too large. This results in (diminishing) oscillations of the actual value around the setpoint. Parameter T_v should be adjusted again using the formula: $T_v = T_n \times 0.75$.

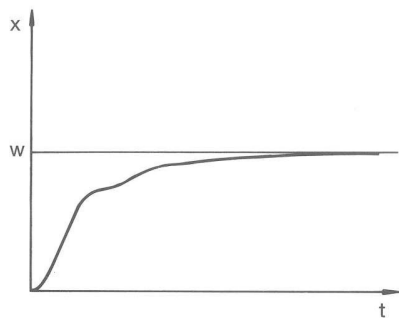

Fig. 35: Control parameters T_n and T_v too large

The actual value increases relatively steeply after specification of the set-point. The proportional range appears to be well-adjusted. The approach to the setpoint becomes significantly slower for diminishing control deviation. The strong reduction of the proportional part (P part) must be compensated for by the integration part (I part). In this case, the I part integrates too slowly. The parameter T_n which specifies the integration interval must be reduced. The lead time (parameter T_v) should also be adjusted using the following formula: $T_v = T_n \times 0.75$.

6.11.2 Opening the control menu

Personnel: Operating personnel

1. Change to the main menu.
2. Select the menu item *Setup* → *Control*.

6.11.3 Overview of internal control parameters

The internal control compares the set temperature with the outflow temperature and calculates the actuating signal, i.e. the measurement used for heating or cooling.

Table 6: The following control parameters can be adapted for internal control:

Characteristics	Designation	Unit
X_p	Proportional range	K
T_n	Adjustment time	s
T_v	Hold-back time	s
T_d	Attenuation time	s



If T_v manual/auto is set to auto, T_v and T_d cannot be modified. In this case, they are derived with fixed factors of T_n .



The temperature limits T_{ih} and T_{il} also have an effect on the control.

6.11.4 Adapting internal control parameters

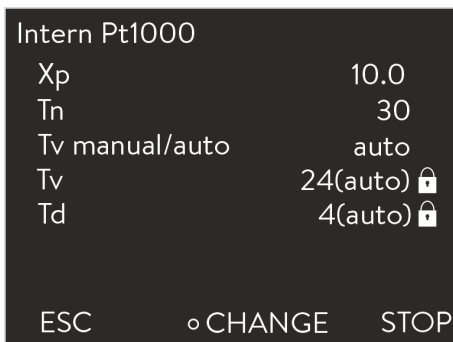

Fig. 36: Internal control parameter menu

Personnel: Operating personnel

1. Select the menu item *Control parameter* → *intern Pt1000* in the Control menu.
2. Select one of the following options:
 - You can select one of the listed control parameters.
 - *Tv manual/auto* allows you to specify whether the control parameters T_v and T_d are set manually or automatically. If the automatic setting is active, the two control parameters are displayed with a padlock and cannot be selected. In this case, they are derived with fixed factors from T_n .

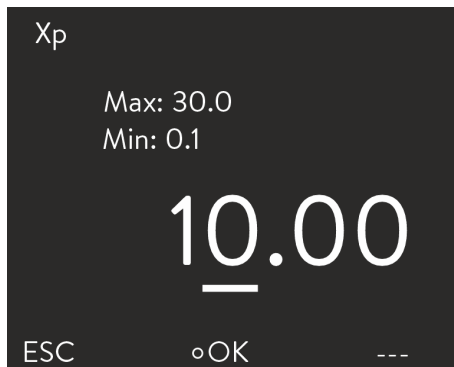

Fig. 37: Specifying internal control parameters

3. Press the input button to confirm.
 - ▶ Selection of the menu item *Tv manual/auto* activates manual or automatic adjustment of the parameters depending on the previous setting. An entry window is displayed if the other menu items are selected. The respective value can be adjusted within the displayed limits.
4. Change the value accordingly.
5. Press the input button to confirm.

6.11.5 Overview of external control parameters

- External control consists of a master controller (external controller) and a slave controller (internal controller). The temperature of the consumer to be temperature controlled is also required. In general this is determined with an external “Pt100 sensor”.
- The master controller compares the set temperature with the external temperature (consumer temperature) and, from these temperatures, calculates the set temperature (set_internal) for the slave controller (internal controller).
- The slave controller compares the set temperature (set_internal) with the outflow temperature and calculates the actuating signal, i.e. the measurement used for heating or cooling.

Table 7: The following control parameters can be adapted on the master controller (external controller):

Characteristics	Designation	Unit
K _{pe}	Amplification factor	-
T _{ne}	Adjustment time	s
T _{ve}	Hold-back time	s
T _{de}	Attenuation time	s
Prop_E	Proportional range	K

Table 8: The following control parameters can be adapted on the slave controller (internal controller):

Characteristics	Designation	Unit
X _{pf}	Proportional range	K



If $Tv\ manual/auto$ is set to $auto$, Tv and Tde cannot be modified. In this case, they are derived with fixed factors of Tne .



The temperature limits T_{ih} and T_{il} also have an effect on the control.

Correction limitation

If a temperature jump is specified via set temperature T_{set} , the control may set an outflow temperature which is considerably higher (e.g. 50 K, possible problem with enamel reactors) than the temperature T_{ext} required in the external application. Therefore, there is a correction limitation that specifies the maximum permitted deviation between the temperature at the outflow T_{int} and the temperature in the external consumer T_{ext} .

1. Press the [Enter key] to open the menu.
2. Select the menu items \rightarrow Setup \rightarrow Control \rightarrow Correction limit..
 - ▶ An entry window opens for the numerical value.
3. Enter the value.
4. Confirm the new value with the [Enter key].
 - ▶ The new value has been accepted.

6.11.6 Adjusting external control parameters

Personnel: Operating personnel

1. Select the menu item *Control Parameter* \rightarrow *extern Pt100* in the Control menu.
2. Select one of the following options:
 - You can select any of the listed control parameters.
 - With *Tv manual/auto*, you can define whether the control parameters *Tve*, *Tde* and *Prop_E* are set manually or automatically. If the automatic setting is active, both control parameters are displayed with a lock symbol and cannot be selected. *In this case*, *Tve* and *Tde* are derived with fixed factors from *Tne*.
3. Confirm with the ENTER button.
 - ▶ Selection of the menu item *Tv manual/auto* activates manual or automatic control depending on the previous setting. An input window is displayed when the other menu items are selected.
4. Adjust the value accordingly.
5. Confirm with the ENTER button.

6.12 Basic settings

6.12.1 Calling the basic settings

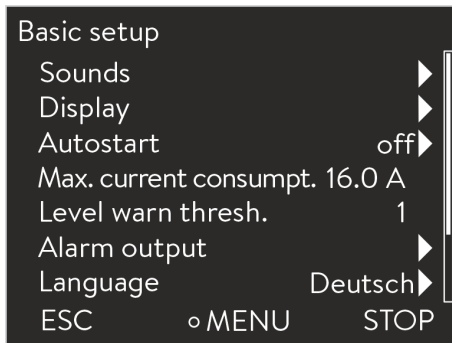

Fig. 38: Basic settings menu

1. Switch to the main menu.
2. Select the *Setup* → *Basic setup* menu item.

The basic settings are described in the following chapters.

6.12.2 Adjusting the volume of the signal tones

The devices indicate alarms and faults with a two-tone acoustic signal. Warnings are signaled as a continuous tone.

Personnel: Operating personnel

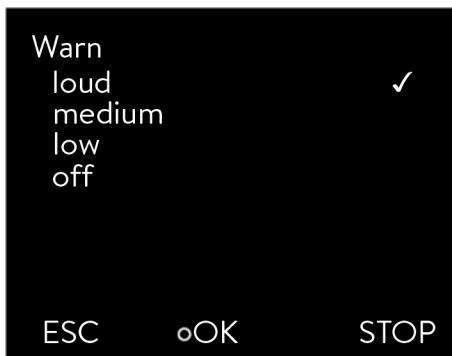

Fig. 39: Adjusting volume

1. Switch to the main menu.
2. Select the *Setup* → *Basic setup* → *Sounds* menu item.
3. Select one of the options depending on which sound you wish to adjust.
4. Select a volume.
5. Press the input button to confirm.

6.12.3 Adjusting the display brightness

The devices are fitted with a sensor that automatically adapts the display brightness to the ambient brightness.



Manual adjustment of the brightness of the display is not absolutely necessary with the "automatic" setting.



Fig. 40: Adjusting brightness

Personnel: Operating personnel

1. Switch to the main menu.
2. Select the *Settings* → *Basic setting* → *Display* → *Brightness* menu item.
3. The following options are available in the entry window
 - The brightness is adjusted automatically with the default setting *automatic*.
 - You can set the brightness manually with the *Level* options. The brightness intensifies from *Level 1*. The respective brightness immediately becomes visible on the display.
 - You can completely switch off the backlight for the display with *off*.
4. Press the input button to confirm.

6.12.4 Specifying the starting mode (Auto start)

The device will not automatically resume operation after a power failure and restoration of the power supply. You can set the device to switch to Standby mode after restoration of the power supply.

Personnel: Operating personnel



Fig. 41: Selecting auto start setting

1. Switch to the main menu.
2. Select the *Settings* → *Basic setting* → *Auto start* menu item.
3. Select one of the following options
 - The device switches to Standby mode when the power is restored with *off*.
 - The device continues operation (with the settings before the power failure) after power has been restored with *on*.
4. Press the input button to confirm.

6.12.5 Limiting the current consumption

If your mains fuse is less than 16 A, the current consumption can be reduced in steps from 16 A to 8 A. This may impair the control accuracy. Establish whether other consuming units or only your device is connected to the fused circuit.

Personnel: Operating personnel

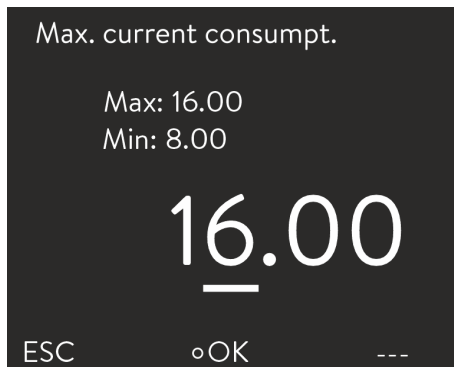

Fig. 42: Specifying current consumption

1. Switch to the main menu.
2. Select the *Settings* → *Basic setting* → *Current consumption* menu item.
3. Change the current consumption accordingly.
4. Press the input button to confirm.

6.12.6 Configuring the alarm level for the fill level

A warning about low level of the device is usually output on the device starting from the second level stage. However, the alarm level before low level can be configured within a specific range.

Personnel: Operating personnel



Fig. 43: Specifying the Alarm level

1. Switch to the main menu.
2. Select the *Setup* → *Basic setup* → *Level warn stage* menu item.
3. You can select from four stages 0 to 3 for the warning before low level. With 3, a warning about low level is output from the third level stage. With 0, no warning at all is output. In this case, the device is switched off and an alarm displayed when low level is reached.
4. Press the input button to confirm.

6.12.7 Setting the alarm output

An option is always active in the Alarm output menu. The selected option is marked with a check mark. A fault in the device could be an alarm or an error.

Table 9: Possible options

Options	Description
Only alarms	Signal output (e.g. for reverse flow protection, pilot lamp)
Alarms and Stand-by	Signal output and device switched to Standby

Personnel: Operating personnel

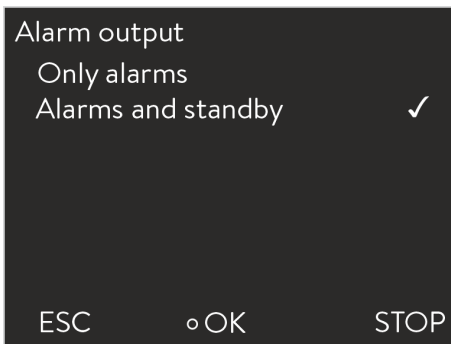

Fig. 44: Configuring the alarm output

1. Switch to the main menu.
2. Select the *Setup* → *Basic setup* → *Alarm output* menu item.
3. The following options are available:
 - With *Only alarms*, a signal is only output at the alarm output in the event of device alarms.
 - With *Alarms and standby*, a signal is also output in Standby.
4. Press the input button to confirm.

6.12.8 Selecting the menu language

The menu languages English, German, French, Spanish, and Italian are available for the device display.

Personnel: Operating personnel



Fig. 45: Selecting the menu language

1. Switch to the main menu.
2. Select the *Setup* → *Basic setup* → *Language* menu item.
3. Select one of the available languages.
4. Press the input button to confirm.

6.13 Entering the offset of the internal actual temperature (calibration)



The factory calibration is overwritten during the adjustment. A reference thermometer with the desired degree of accuracy is required. In other respects, the factory calibration should not be changed.

If a temperature deviation is discovered when checking the constant temperature equipment with a calibrated reference thermometer, the deviation can be corrected.

The sensor of the reference thermometer must be installed in the inlet of the device in accordance with the specifications on the calibration certificate.

Personnel: Operating personnel

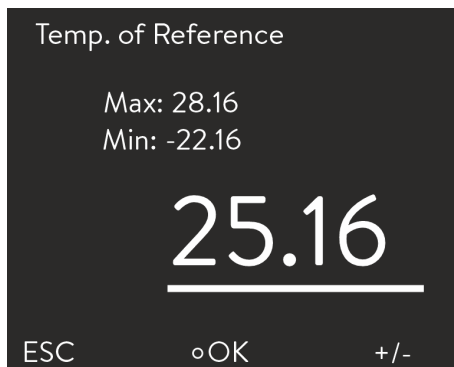

1. Switch to the main menu.
2. Select the *Setup* → *Calibration* → *Calibration* menu item.
3. Change the value accordingly. The value displayed on the reference thermometer must be entered.
4. Press the input button to confirm.

Fig. 46: Specifying the offset

6.14 Restoring the factory calibration (internal temperature probe)

An offset specified for the internal temperature measurement can be reset.

Personnel: Operating personnel

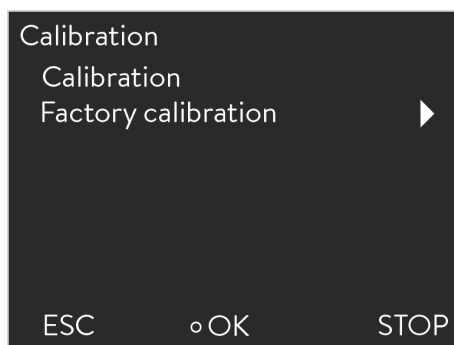

1. Switch to the main menu.

Fig. 47: Factory calibration

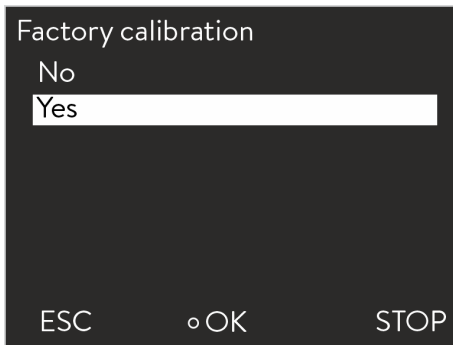

Fig. 48: Restoring the factory calibration

2. Select the *Setup* → *Calibration* → *Factory Calibration* menu item.
3. Select one of the following options:
 - You return to the previous display without making any changes with *no*.
 - The factory calibration is restored with *yes*.

6.15 Restore factory setting

Navigating to the factory setting

Personnel: Operating personnel

1. Switch to the main menu.
2. Select the *Setup* → *Factory setting* menu item.

Restoring individual settings

Personnel: Operating personnel

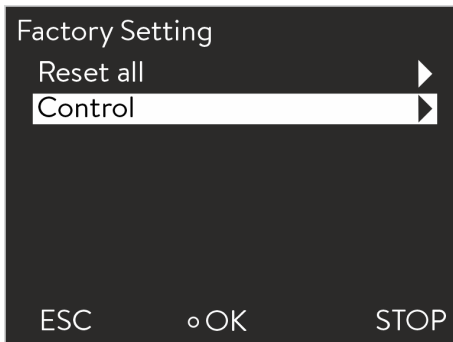

Fig. 49: Selecting the mode

1. Select the *Control* menu item.
 - ▶ This takes you to a list which enables you to reset the parameters individually.

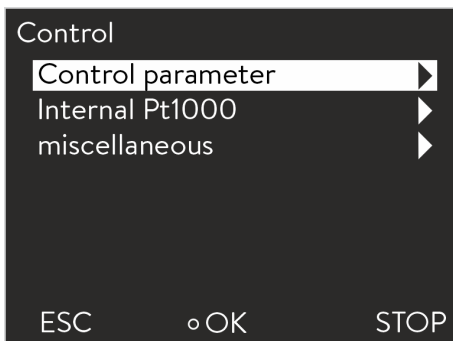

Fig. 50: Resetting the control parameters

2. Select the relevant menu item in the parameter list.
 - You can reset the internal and external control parameters with *Control parameters*.
 - You can reset the settings for the internal sensor with *internal Pt1000*.
 - You can reset the set point and maximum current consumption with *miscellaneous*. The control is also set to internal control.
3. Select one of the following options in the entry window:
 - You return to the previous display without making any changes with *no*.
 - Selecting *yes* resets the selected parameter if you confirm this with the Enter button.

Restoring all settings

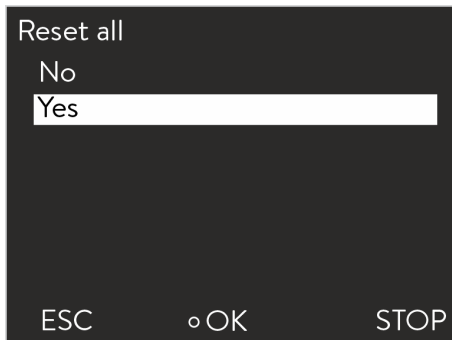

Fig. 51: Reset query

6.16 Device status

6.16.1 Viewing the device status

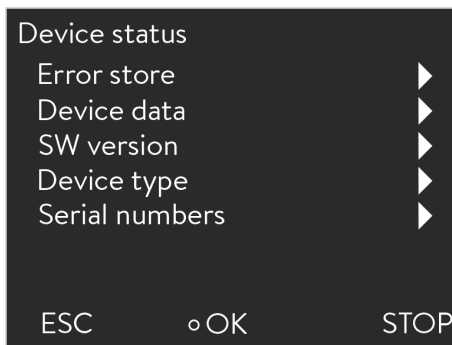

Fig. 52: Device status

6.16.2 Reading the Error store

Personnel: Operating personnel

1. Select the *all default* menu item.
2. Select one of the following options:
 - You return to the previous display without making any changes with *no*.
 - The factory settings are restored with *yes* if you confirm this with the Enter button.

Personnel: Operating personnel

1. Switch to the main menu.
2. Select the *Setup* → *Device status* menu item.
 - ▶ You are in the Device status menu.
3. The following options are available:
 - Read out error memory
 - View device data
 - View software version
 - View device type
 - Retrieving serial numbers

The devices are provided with an Error store for error analysis. Up to 140 warning, error and alarm messages can be stored here.

1. Select the *Error store* menu item in the Device status menu.



The most recent message appears in the first position. The message text is displayed in the footer.

No.	Source	Code	Type	Date	Time
5	Control	29	Error	3/20/20	10:32
4	Safety	3	Alarm	3/20/20	10:32
3	Control	4	Warn	3/20/20	9:41
2	Safety	29	Error	3/19/20	17:17
1	Control	36	Error	3/19/20	15:02

Protection system (3):
Overtemperature
ESC ○ OK STOP

Fig. 53: Error store

2. You can navigate through the list using the up and down arrow keys.

The following information is displayed for each message:

- The relevant module that triggered the message is displayed under *Source*.
- *Code* is the encoded description of the alarm, warning or error.
- *Type* specifies whether it is an alarm, warning or error.
- *Date* and *Time* display the exact time the message was issued.



You will find a list of the possible alarms, warnings and errors in the "Procedure in the event of alarms" on page 73.

6.16.3 Retrieving device data

Device data	
T_int	22.23 °C
T_ext	-6.33 °C
T_exta	23.04 °C
T_exts	22.38 °C
T_extEth	-36.33 °C
Tlp	28.05 °C
T_a	30.93 °C
ESC	○ --- STOP

Fig. 54: Device data

1. Select the *Device data* menu item in the Device status menu.
 - ▶ Various current parameters are displayed.

6.16.4 Retrieving the software version

Amongst other things, the respective software versions are needed for service cases.

Personnel: ■ Operating personnel

1. Select the *SW version* menu item in the Device status menu.
 - ▶ The respective software versions are displayed depending on the device type and the connected modules.

6.16.5 Displaying device type

The device type is shown directly at the menu item *Type* in the Device status menu.

6.16.6 Displaying serial numbers

Personnel: Operating personnel

1. Select the *Serial numbers* menu item in the Device status menu.
 - ▶ The serial number of the device is displayed. The serial numbers of connected modules are also displayed if they are available.

6.17 Programmer

6.17.1 Program example

The programmer function allows storage of temperature/time programs. The program consists of several temperature/time segments and details about their repetition. Ramps, temperature jumps (time is zero) or temperature-holding phases with identical start and end temperature in the segment are possible. During the start, the current setpoint is stored as the starting value of the first segment.



The total number of freely programmable segments per program is 150.

Up to 5 temperature/time programs can be stored.

Available settings

Setting	Description
No.	Segment number of the program
Tend	End temperature that should be reached
hh	Time in hours (hh) by which the specified temperature should be reached.
mm	Time in minutes (mm) by which the specified temperature should be reached.
Tolerance	The tolerance defines the level of accuracy with which the end temperature should be reached before the next segment will be processed.
S1, S2, S3	The switching state of a contact module (if available) can be programmed here. Contact modules are available as accessory.

The graphic shows an example of reprogramming a setpoint temperature profile.

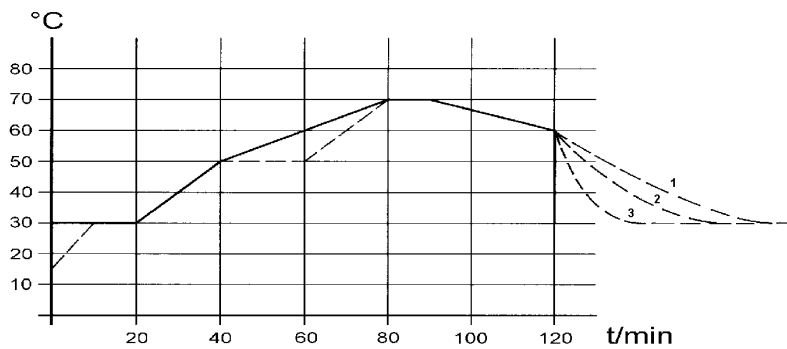

Fig. 55: Program example

The cool-down time in the graph varies depending on the device type, consumer and so on. In example segment No. 2, 50 °C should be reached within 20 minutes.

The original values in the "Before" table provided below are represented by a solid line, while the edited profile of the "After" table is shown by a dashed line.

Table 10: "Before" table

(-)								
No.	Tend	hh	mm	Tol	Pump	S1	S2	S3
Start	30.0 0	--	--	0.1	---	off	off	off
2	50.0 0	0	20	0.0	---	off	off	off
3	70.0 0	0	40	0.0	---	off	off	off
4	70.0 0	0	10	0.1	---	off	off	off
5	60.0 0	0	30	0.0	---	off	off	off
6	30.0 0	0	0	0.0	---	off	off	off

A new segment with the number 3 was entered in the edited table. The time for the segment with number 4 was also changed. The tolerance for the segment with number 5 was adjusted.

Table 11: "After" table

(- - -, editet)								
No.	Tend	hh	mm	Tol	Pump	S1	S2	S3
Start	30.0 0	--	--	0.1	---	off	off	off
2	50.0 0	0	20	0.0	---	off	off	off

(- - -, editet)								
3	50.0 0	0	20	0.1	- - -	off	off	off
4	70.0 0	0	20	0.0	- - -	off	off	off
5	70.0 0	0	10	0.8	- - -	off	off	off
6	60.0 0	0	30	0.0	- - -	off	off	off
7	30.0 0	0	0	0.0	- - -	off	off	off

The entered tolerance can have a great influence with external bath control. The graph on the side of the edited profile clarifies the possible overrun of the actual temperature in the bath vessel (solid line) for the setpoint value of the programmer (grey background).

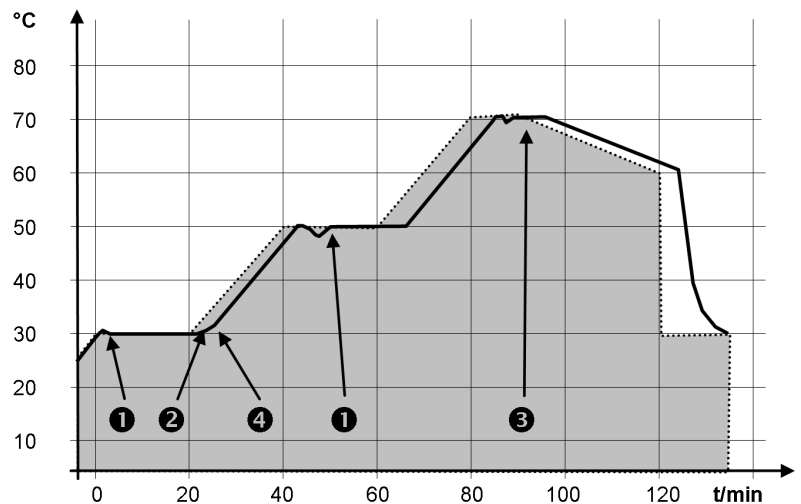

Fig. 56: Program tolerance

Note:

- The tolerance field enables precise adherence to the delay time at a specific temperature. Only once the actual temperature of the tolerance range has been reached (1), will the following segment be processed so that e.g. the ramp of the second segment will not be started until after a delay of 2.
- A tolerance range that has been selected too narrow can also cause undesired delays. The tolerance range should not be too narrow, particularly when external control is used. A larger tolerance was entered in segment 5, so that the desired time of 10 minutes can be adhered to even with transient processes (3).
- Only flat (slow) ramps should be programmed with a tolerance range as needed. Steep ramps that are close to the maximum possible heating or cooling rates of the device may be severely delayed (4) if the tolerance range (here in segment 2) is too narrow.

No time specification is possible in the starting segment (No. 1). The temperature of the first segment is reached as quickly as possible to change to segment 2 after reaching the set tolerance.

6.17.2 Selecting the program

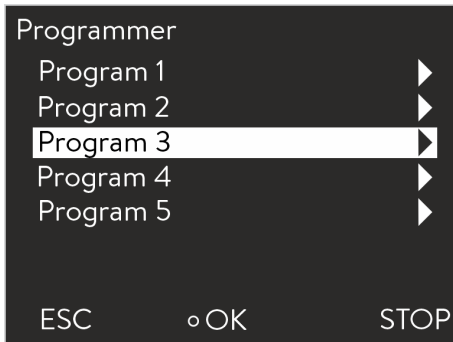

Fig. 57: Selecting the program

Personnel: Operating personnel

1. Switch to the main menu.
2. Select the *Programmer* menu item.
3. Select one of the available programs.

6.17.3 Create and edit programs

Start editing

Please note the following:

- If a segment time > 999:59 h is included, this time must be distributed over several successive segments.

Personnel: Operating personnel

1. Select the *Edit* menu item for the selected program.
2. You can now edit the segments.

No.	Tend	hh	:mm	Tolerance
Start	30.00	---	---	0.1
1	50.00	0	20	0.0
2	50.00	0	20	0.0
3	70.00	0	20	0.1
4	60.00	0	30	0.0
5	30.00	0	0	0.0

ESC ◦NEW DELETE

Fig. 58: Editing a program

Editing segments

Personnel: Operating personnel

Please note the following:

- No time specification is possible in the starting segment. The temperature of the first segment is reached as quickly as possible, in order to change to segment 2 after reaching the set tolerance.
- If the value "0" is entered in the fields *hh* and *mm*, the set point is applied immediately and the bath temperature ramped up as quickly as possible.
- If a tolerance range which is too small is selected in the *Tolerance* field, it is possible that the program will not be continued as the required tolerance is never reached.
- The default setting for contact modules is *off*. The entry "- -" for contact modules stands for no changes to the previous segment, i.e. if "- -" is set in all fields, the contact position of the starting setting or the setting before the program start is maintained.

1. The following options are available:
 - You can display additional columns of the program with the right and left arrow buttons.
 - You can navigate in the segments of a program with the up and down arrow buttons.
 - You can edit a selected segment by pressing the Enter button. You can customize the value with the up and down arrow buttons. Individual digits can be selected with the right and left arrow buttons. Press the Enter button to confirm your changes.

Add new segment

No.	Tend	hh	:mm	Tolerance
Start	30.00	---	---	0.1
1	50.00	0	20	0.0
2	50.00	0	20	0.0
3	70.00	0	20	0.1
4	60.00	0	30	0.0
5	30.00	0	0	0.0
ESC		oNEW		DELETE

Fig. 59: Selecting program segments

Personnel: Operating personnel

1. Navigate to the segment under which the new segment should be added.
2. Navigate to the *No.* column in this segment.
3. Press the Enter key.
 - ▶ A new segment is created.

Delete segment

Personnel: Operating personnel

1. Navigate to the segment that you want to delete.
2. Navigate to the *No.* column in this segment.

3. Press the *Delete* soft key.
 - ▶ The segment is deleted.

Editing a program currently running

Please note the following:

- No segments can be added or deleted in a currently running program.
- In the running program, changes of the existing temperature values and segment durations are possible. The segment is continued as if the change had been effective since the beginning of the segment.
- If the new segment time is shorter than the elapsed segment time, the program jumps to the next segment.

Personnel: Operating personnel

1. Press the *Prog.x/y* soft key in the soft key bar in the Home window.

x represents the currently running program; y represents the current program loop.

2. The currently running program opens.
3. You can now edit the segments of the currently running program.

No.	Tend	hh	:mm	Tolerance
Start	30.00	---	---	0.1
1	50.00	0	20	0.0
2	50.00	0	20	0.0
3	70.00	0	20	0.1
4	60.00	0	30	0.0
5	30.00	0	0	0.0

ESC ◦NEW PROG. 1/1

Fig. 60: The currently running program

Completing editing

Personnel: Operating personnel

1. When you have completed the program, you can return to the program overview with the left arrow button.

6.17.4 Defining program loops

Programmer

Status ▶

Edit ▶

Loops 3

ESC ◦OK STOP

Fig. 61: Setting program loops

Personnel: Operating personnel

1. Select the *Loops* menu item for the selected program.
 - ▶ An entry window appears. The loops can be defined within the displayed limits.

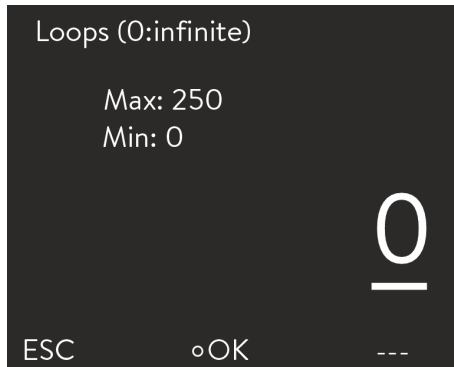

Fig. 62: Setting the number of repetitions

2. Customize the number of program loops as required.



Press the left arrow button to enter two or three digit numbers. Another digit is displayed and can be customized.



If "0" is entered, the program is repeated continuously.

3. Press the input button to confirm.

6.17.5 Starting, interrupting and ending a program

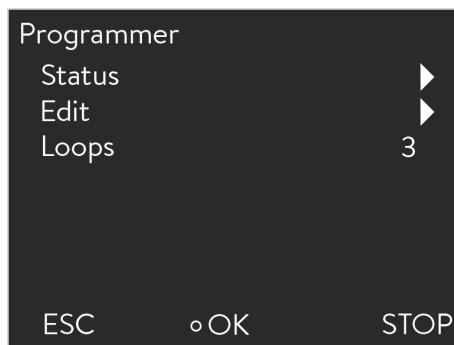

Fig. 63: Programmer menu

Personnel: Operating personnel

1. Select the *Status* menu item for the selected program.
2. The following options are available:
 - Select the option *Start* to start the program.
 - Once the program has started, you can press *Hold* to pause it. A paused program can be continued by pressing *Continue*.
 - Select the option *Stop* to end the program.

7 Maintenance

7.1 General safety instructions



DANGER!
Contact with live or moving parts

Electric shock, impacts, cutting, crushing

- The device must be disconnected from the mains power supply before any kind of maintenance is performed.
- Only skilled personnel are permitted to perform repairs.



DANGER!
Heat transfer liquid drips onto the electronics

Short circuit

- The device must be disconnected from the mains power supply before any kind of maintenance is performed.



CAUTION!
Contact with hot / cold device parts, accessories and heat transfer liquid

Burns, scalding, cold burns

- Bring device parts, accessories and heat transfer liquid to room temperature before touching them.

Also note the following:

- Before conducting maintenance work, ensure that the device has been decontaminated after coming into contact with hazardous materials.

7.2 Maintenance intervals

The maintenance intervals described in the following table must be complied with. The following maintenance work is mandatory before every longer unsupervised operation.

Interval	Maintenance work
monthly	Inspection the drain tap for leaks by visual inspection from the outside
	Inspection of the external hoses for material fatigue and leaks
	Inspection of the hose clips for correct and secure fit
	Inspection of the low level safety function
	Cleaning of the condenser (only for air-cooled devices)
	Cleaning of the water filter (only for water-cooled devices)

Interval	Maintenance work
quarterly	Decalcifying of the cooling water circuit (only for water-cooled devices) A shorter interval must be selected, depending on water hardness and operating time
half-yearly	Inspection of the heat transfer liquid

7.3 Cleaning the surfaces of the device

Personnel: Operating personnel



WARNING!
Risk of cleaning agent entering the device

Electric shock

- Only use a slightly damp cloth for cleaning.



NOTICE!
Cleaning agents corrode surface structures

Damage to the device surfaces

- Do not use cleaning agents containing acetone, ethanol or other solvents for cleaning work.

1. Clean as follows:
 - Clean the control element using a wet cloth with a drop of washing-up liquid.
 - Clean painted sheet metal parts with a cloth and commercial industrial cleaner.

7.4 Checking the low-level protection

An alarm signal sounds if the liquid level decreases to the extent that the heater is no longer completely covered with liquid. *Low Level* is shown in the display. The components of the device, cooling unit, heater and pump are switched off via the electronics system.



An alarm must sound as soon as the minimum level is reached.

The liquid level in the device is shown in the display.

1. Switch on the device. Set the set temperature to room temperature.
2. Lower the liquid level in the device. Drain heat transfer liquid via the drain tap for this purpose.
 - ▶ The display shows that the heat transfer liquid is sinking.
The device switches off if the liquid level is too low. The message *Low Level* appears in the display.

3. Close the drain tap and top up the heat transfer liquid.
 - ▶ The liquid level in the display rises.
4. Unlock the display with the Enter button.
 - ▶ The device restarts.

7.5 Cleaning the air-cooled condenser

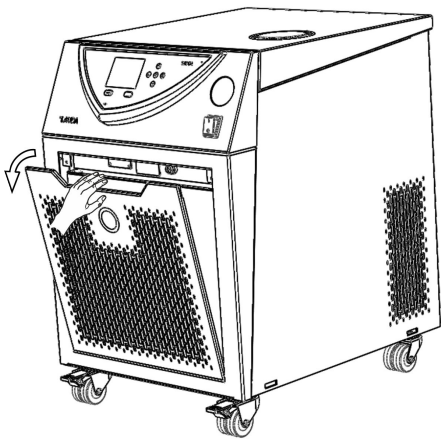

Fig. 64: Removing the front panel

Personnel: Operating personnel

1. Switch off the device.
2. Carefully remove the front panel. Grasp the front panel at the recess, pull it towards you and lift it out of the guide.



The front panel is held in place by a magnetic catch.

3. Brush off or vacuum the condenser.
4. Install the front panel again with care.

7.6 Cleaning the water filter

This section is relevant for:

- Water-cooled devices

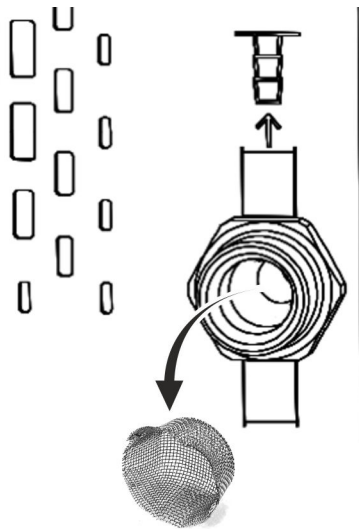

Fig. 65: Removing the water filter

7.7 Descaling the cooling water circuit

Personnel: Operating personnel

1. Switch off the device at the mains switch.
2. Unscrew the cooling water hose from the threaded connection of the water cooling intake.
3. Carefully remove the water filter from the intake nozzle.



Use tweezers to remove/insert the water filter if necessary.

4. Clean the water filter and then re-insert it in the intake nozzle.
5. Screw the cooling water hose back on the threaded connection of the water cooling intake.

This section is relevant for:

Water-cooled devices

A pump or a funnel is used to fill the device with descaler via the water cooling supply hose. The descaler flows back out through the water cooling return hose and into a container with a sufficient volume (at least 10 liters).

Personnel: Operating personnel

Protective equipment: Safety glasses
 Protective gloves
 Protective work clothing

1. Switch off the device at the mains switch.
2. Dissolve the descaler in a bucket of water.



LAUDA descaler is required for the descaling process (catalog number LZB 126, 5 kg pack). Read the safety information and instructions on the packaging before using the chemicals.

3. Unscrew the cooling water hose from the threaded connection of the water cooling intake.
4. Remove and clean the water filter of the device. The water filter is located in the water cooling intake nozzle.



You will find more information on cleaning the water filter in Chapter 7.6 "Cleaning the water filter" on page 70.

5. Leave the cooling water hose on the outlet on the device. Place the other end of the hose in a large container.

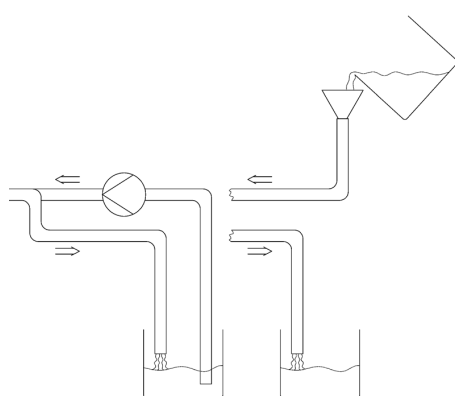



Fig. 66: Descaling

6. Switch the device on and set the set point to 10 °C. After the cooling unit has been started, fill the device with LAUDA descaler via the water cooling supply hose. Use a pump or a funnel.
7. Continuously top up and pump the descaler. Continue this process until the foaming reaction had subsided. This usually takes approx. 20 to 30 minutes.
8. Then drain the condenser.



Refer to  Chapter 9.2 “Draining the condenser” on page 79 for detailed information on draining the condenser.

9. Rinse the cooling water circuit of the device thoroughly with clean water.



Allow a minimum of 10 liters of water to flow through the system.

10. Reconnect the device to the cooling water supply.

7.8 Check the heat transfer liquid

Contaminated or diluted heat transfer liquid must be replaced. Continued use of the heat transfer liquid is only permitted following successful testing.

The heat transfer liquid must be tested as outlined in DIN 51529.

8 Faults

8.1 Alarms, errors and warnings

Any alarms, error signals and warnings triggered on the device are shown as plain text on the screen.

Procedure in the event of alarms

Alarms are relevant for safety. The components of the device such as the pump switch off. A two-tone signal is output by the device. Alarms can be cancelled with the ENTER button after rectification of the cause of the fault.

You can find a list of alarms in ↪ Chapter 8.2 “Alarm codes” on page 73.

Procedure in the event of warnings

Warnings are not relevant for safety. The device continues running. A continuous tone is output for a short time by the device. Warnings are output periodically. Warnings can be cancelled with the ENTER button after rectification of the cause of the fault.

A list of warnings can be found in ↪ Chapter 8.5 “Warnings - control system” on page 75 and ↪ Chapter 8.6 “Warnings – safety system” on page 76.

Procedure in the event of errors

A two-tone signal is output if any error occurs.

In the case of an error, switch off the device at the mains power switch. If the error occurs again after restarting the device, note the error code and the associated description and contact LAUDA Constant Temperature Equipment service. Contact details can be found in ↪ Chapter 13.4 “Contact LAUDA” on page 91.



Errors are displayed with the appropriate description and an error code in the form of a consecutive number.

8.2 Alarm codes

Code	English output	Description
02	Low Level	Low level detected by float switch
03	Overtemperature	Bath / outlet temperature higher than Tmax
09	T ext Pt100	External Pt100 actual value is not present
10	T ext analog	External analog actual value is not present
11	T ext seriell	External serial actual value is not present
12	Input Analog 1	Analog module: Current input 1, interruption.
13	Input Analog 2	Analog module: Current input 2, interruption.
14	T ext serial	No signal for actual value via the USB interface
15	Digital Input	Fault at the digital input / switch contact
20	T ext Ethernet	No signal for actual value via the Ethernet module

8.3 Low level alarm

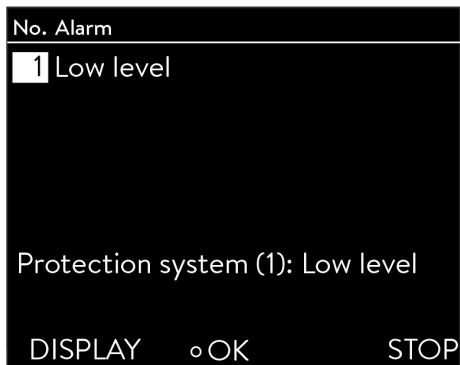

Fig. 67: Low Level Alarm

- An alarm signal sounds if the liquid level falls below the minimum level.
- *Low Level* appears in the display. The components of the device, e.g. the pump, are switched off via the electronics system.

Rectifying a fault

Personnel: ■ Operating personnel

1. Top up the missing heat transfer liquid.
2. Unlock the display with the Enter button.
 - ▶ The device restarts.

8.4 Overtemperature alarm



Fig. 68: Overtemperature alarm

If the temperature exceeds 90 °C, 3 *overtemperature* alarm is triggered and a two-tone acoustic signal sounds.

The heaters, cooling system and pump are switched off as a result of this alarm.

1. Switch off the device.
2. Allow the device to cool down (> 20 minutes).
3. Switch on the device.
4. Press the *OK* key to acknowledge the alarm.

8.5 Warnings - control system



All warnings of the control system start with the prefix 0. The prefix is followed by two additional numbers. These numbers are listed in the following table.

Code	English output	Description
001	CAN receive overflow	Overflow during CAN reception
002	Watchdog reset	Watchdog reset
003	T_il limit active	til-limit active
004	T_ih limit active	tih-limit active
005	Corrupt parameter	Inadmissible internal parameter
006	Corrupt programme	Inadmissible programmer data
007	Invalid parameter	Inadmissible parameter in memory
008	CAN system	Problem during internal data exchange
009	Unknown module	Unknown module connected
010	SW Control too old	Software version of control system too old
011	SW Safety too old	Software version of safety system too old
012	SW Command too old	Software version of remote control unit Command too old
013	SW Cool too old	Software version of cooling module too old
014	SW Analogue too old	Software version of analogue module too old
015	SW Serial too old	Software version of serial interface (RS 232) too old
016	SW Contact old	Software version of contact module too old
017	SW Valve 0 old	Software version of solenoid valve 0 too old
018	SW Valve 1 old	Software version of solenoid valve 1 too old
019	SW Valve 2 old	Software version of solenoid valve 2 too old
020	SW Valve 3 old	Software version of solenoid valve 3 too old
021	SW Valve 4 old	Software version of solenoid valve 4 too old
022	SW Pump 0 old	Software version of pump 0 too old
023	SW Pump 1 old	Software version of pump 1 too old
024	SW Pump 2 old	Software version of pump 2 too old
025	SW Pump 3 old	Software version of pump 3 too old
026	SW HTC old	Software version of high temperature cooler too old
027	SW Ext. Pt100 old	Software version of external Pt100 too old
028	SW Ethernet old	Software version of Ethernet too old

Code	English output	Description
029	SW EtherCAT old	Software version of EtherCAT too old
033	Clock wrong time	Internal clock defective; battery power supply was/is interrupted (insert new battery)
034	Tset: Prog. is running	Setpoint was changed while the programmer is running.
041	Wrong mains voltage	Incorrect mains voltage setting
042	No VC type	Device type not configured
043	No VC voltage	Mains voltage not configured
050	Level very low	Level too low, top-up heat transfer liquid
051	Level high	Level too high (fill level of the heat transfer liquid too high, risk of bath overflow)
055	CAN buff. overflow	Buffer overflow for CAN reception

8.6 Warnings – safety system



All warnings of the safety system start with the prefix 1. The prefix is followed by two additional numbers. These numbers are listed in the following table.

Code	English output	Description
101	CAN receive overflow	Overflow during CAN reception
102	Watchdog Reset	Watchdog reset
103	Heating not correct	Heaters have different outputs
104	Heat 1 failed	Heater 1 defective
105	Heat 2 failed	Heater 2 defective
106	Heat 3 failed	Heater 3 defective
107	Invalid Parameter	Inadmissible parameter in memory
108	CAN system	Problem during internal data exchange
109	Unknown Modul	Unknown module connected
110	SW Control too old	Software version of control system too old
111	SW Safety too old	Software version of safety system too old
112	SW Command too old	Software version of command remote control unit too old
113	SW Cool too old	Software version of cooling module too old
114	SW Analog too old	Software version of analogue module too old
115	SW Serial too old	Software version of serial interface (RS 232) too old
116	SW Contact too old	Software version of contact module too old
117	SW Valve 0 old	Software version of solenoid valve 0 too old

Code	English output	Description
118	SW Valve 1 old	Software version of solenoid valve 1 too old
119	SW Valve 2 old	Software version of solenoid valve 2 too old
120	SW Valve 3 old	Software version of solenoid valve 3 too old
121	SW Valve 4 old	Software version of solenoid valve 4 too old
122	SW Pump 0 old	Software version of pump 0 too old
123	SW Pump 1 old	Software version of pump 1 too old
124	SW Pump 2 old	Software version of pump 2 too old
125	SW Pump 3 old	Software version of pump 3 too old
126	SW HTC old	Software version of high temperature cooler too old
127	SW Ext. Pt100 old	Software version of external Pt100 too old
128	SW Ethernet old	Software version of Ethernet too old
129	SW EtherCAT old	Software version of EtherCAT too old
155	CAN buff. overflow	Buffer overflow for CAN reception

8.7 Warnings - SmartCool



All warnings of the SmartCool system start with the prefix 3. The prefix is followed by two additional numbers. These numbers are listed in the following table.

Code	English output	Description
301	CAN receive overflow	Overflow during CAN reception
302	Watchdog reset	Watchdog reset
303	Missing SM adaptation	Adaptation run not performed
304	Pressure switch activated	Pressure switch in schema cooling circuit was triggered
305	Clean condenser	Clean the condenser
306	TO1 out of range (Klixon)	Injection temperature outside value range
307	Invalid parameter	Inadmissible parameter in memory
308	CAN system	Problem during internal data exchange
309	Unknown module	Unknown module connected
310	SW Control too old	Software version of control system too old
311	SW Safety too old	Software version of safety system too old
312	SW Command too old	Software version of command remote control unit too old
313	SW Cool too old	Software version of cooling module too old
314	SW Analogue too old	Software version of analogue module too old

Code	English output	Description
315	SW Serial too old	Software version of serial interface (RS 232) too old
316	SW Contact old	Software version of contact module too old
317	SW Valve 0 old	Software version of solenoid valve 0 too old
318	SW Valve 1 old	Software version of solenoid valve 1 too old
319	SW Valve 2 old	Software version of solenoid valve 2 too old
320	SW Valve 3 old	Software version of solenoid valve 3 too old
321	SW Valve 4 old	Software version of solenoid valve 4 too old
322	SW Pump 0 old	Software version of pump 0 too old
323	SW Pump 1 old	Software version of pump 1 too old
324	SW Pump 2 old	Software version of pump 2 too old
325	SW Pump 3 old	Software version of pump 3 too old
326	SW HTC old	Software version of high temperature cooler too old
327	SW Ext. Pt100 old	Software version of external Pt100 too old
328	SW Ethernet old	Software version of Ethernet module too old
329	SW EtherCAT old	Software version of EtherCAT too old
341	sm0 min too small	Starting value of injection valve too low
344	chiller missing	Refrigerant unit does not run
345	Valve not closed	Valve of the cooling circuit does not close
347	Configure EEV0	Contact LAUDA Service
348	Configure EEV1	Contact LAUDA Service
349	Preheat unit	A warning concerning possible damage to the cooling system is sent when the device is operated below 5 °C. The cooling system must be preheated to prevent damage. This is automatically performed when outside installation is activated.
355	CAN buff. overflow	Buffer overflow for CAN reception

9 Decommissioning

9.1 Drain the device

Personnel: Operating personnel



WARNING!
Contact with hot or cold heat transfer liquid

Scalding, cold burns

- Bring the heat transfer liquid to room temperature before draining.

Also note the following:

- Observe the regulations for the disposal of used heat transfer liquid.
1. Switch off the device.
 2. Let the device and the heat transfer liquid cool down or heat up to room temperature.
 3. Position a container with appropriate capacity directly under the drain tap.



Several draining processes are required for devices with high fill capacity.

4. Open the drain tap. Turn the lever to the right for this.

9.2 Draining the condenser

This section is relevant for:

- Water-cooled devices

Personnel: Operating personnel

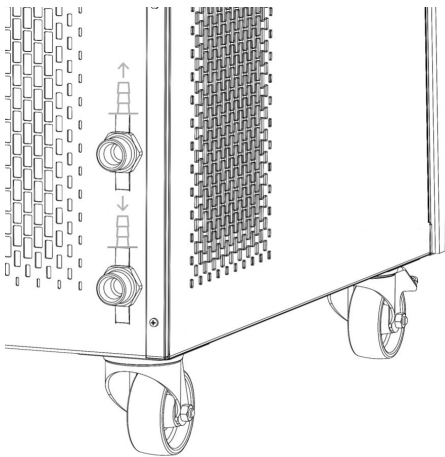

Fig. 69: Cooling water connection socket

1. Bring the device to a temperature of approx. 20 °C. Switch the device off.
2. Close the cooling water intake.
3. Unscrew the cooling water hose from the threaded connection of the water cooling intake.
4. A water filter is located in the water cooling intake nozzle. Carefully remove the water filter from the intake nozzle.



You will find more information on removing the water filter in Chapter 7.6 “Cleaning the water filter” on page 70.

5. Clean the water filter of the device. Then re-insert it in the intake nozzle.
6. Leave the cooling water hose on the outlet on the device. Place the other end of the hose in a drain or a large container.

7. Switch the device on and set the set point on the device to 10 °C.
8. Blow compressed air into the water inlet immediately after starting the compressor. Continue blowing compressed air through the device until all the cooling water has flowed out of the device.
9. Switch off the device.

10 Disposal

10.1 Disposing of refrigerant

Disposal of refrigerant must proceed according to regulation 2015/2067/EU in combination with regulation 517/2014/EU.



CAUTION!
Uncontrolled escape of refrigerant

Impacts, cutting

- Only specialized personnel are permitted to perform disposal work.



NOTICE!
Uncontrolled escape of refrigerant

Environment

- Never dispose of a cooling circuit that is still pressurized.
- Only specialized personnel are permitted to perform disposal work.



The type and refrigerant charge are printed on the rating label.

Have repair and disposal carried out only by a refrigeration technician.

10.2 Device disposal



The following applies for EU member states: The device must be disposed of according to Directive 2012/19/EU (WEEE Waste of Electrical and Electronic Equipment).

10.3 Disposing of packaging

The following applies for EU member states: Disposal of the packaging must proceed according to regulation 94/62/EC.

11 Technical data

11.1 General and type-specific data



The device sound pressure level is below 70 dB. According to EC Directive 2006/42/EC the sound pressure level of the devices is therefore not specified further.

Table 12: General data

Specification	Value	Unit
IP protection level	IP 32	---
Class division for laboratory equipment according to DIN 12 876-1		
- Class designation	I	---
- Identification code	NFL (suitable for non-flammable liquids)	---
Protection class for electrical equipment DIN EN 61 140 (VDE 0140-1)	1	---
Display	TFT display, 3.5", 320 x 240 pixels	---
Resolution of indication	±0.01	°C
Setting resolution	±0.01	°C

Installation location

- Ensure that adequate ventilation is provided
- Minimum free room volume, room volume per kg of refrigerant according to DIN 378-1
(For refrigerant quantity, see type plate or ↗ Chapter 11.3 "Refrigerant and filling quantity" on page 84).

Table 13: Refrigerant and room volume

Refrigerant	Room volume per kg of refrigerant
R-449A	2.81 m ³ /kg
R-452A	2.37 m ³ /kg

Table 14: Type-specific data

Device	Working temperature range	Temperature stability	Dimensions (W x D x H)	Weight
Unit	°C	K	mm	kg
VC 1200	-20 – 80	±0.05	450 x 550 x 650	54
VC 1200 W	-20 – 80	±0.05	450 x 550 x 650	51
VC 2000	-20 – 80	±0.05	450 x 550 x 650	57
VC 2000 W	-20 – 80	±0.05	450 x 550 x 650	54
VC 3000	-20 – 80	±0.05	550 x 650 x 970	93
VC 3000 W	-20 – 80	±0.05	550 x 650 x 970	89
VC 5000	-20 – 80	±0.05	550 x 650 x 970	98
VC 5000 W	-20 – 80	±0.05	550 x 650 x 970	94
VC 7000	-25 – 80	±0.1	650 x 670 x 1250	138
VC 7000 W	-25 – 80	±0.1	650 x 670 x 1250	131
VC 10000	-25 – 80	±0.1	650 x 670 x 1250	147
VC 10000 W	-25 – 80	±0.1	650 x 670 x 1250	140

The housing is 140 mm higher on the devices VC 1200 (W) and VC 2000 (W), which have a more powerful pump.

Free space around the device

Table 15: Air-cooled devices

Device	Free space around the device	Exhaust air (air-cooled devices)
	cm (front/back/right/left)	m ³ /h
VC 1200	20/20/20/20	650
VC 2000	20/20/20/20	650
VC 3000	50/50/20/20	1300
VC 5000	50/50/20/20	2500
VC 7000	50/50/20/20	4500
VC 10000	50/50/20/20	4500

Table 16: Water-cooled devices

Device	Free space around the device
	cm (front/back/right/left)
VC 1200 W	20/20/0/0
VC 2000 W	20/20/0/0
VC 3000 W	20/20/0/0

Device	Free space around the device
VC 5000 W	20/20/0/0
VC 7000 W	20/20/0/0
VC 10000 W	20/20/0/0

11.2 Cooling output

Table 17: Device cooling output

Cooling output at	(20 °C)	(10 °C)	(0 °C)	(-10 °C)	(-20 °C)	(-25 °C)
Device	kW	kW	kW	kW	kW	kW
VC 1200 (W)	1.20	1.00	0.70	0.40	0.14	---
VC 2000 (W)	2.00	1.50	1.06	0.68	0.38	---
VC 3000 (W)	3.00	2.40	1.68	0.95	0.45	---
VC 5000 (W)	5.00	3.90	2.75	1.70	0.90	---
VC 7000 (W)	7.00	5.30	3.70	2.40	1.30	0.65
VC 10000 (W)	10.00	7.60	5.30	3.50	2.00	1.30



The cooling output is measured when the heat transfer liquid reaches a certain temperature. These temperature values are specified in brackets. The ambient temperature for the measurement is 20 °C and ethanol was used as a heat transfer liquid. To measure water-cooled devices, the cooling water temperature is 15 °C and the cooling water differential pressure is 3 bar.

Cooling water connection socket

All water-cooled Variocool devices are equipped with the following cooling water connection:

- ¾" outer connection thread

11.3 Refrigerant and filling quantity

The device contains fluorinated greenhouse gases.

Table 18

	Unit	VC 1200	VC 2000	VC 1200 W	VC 2000 W
Refrigerant	---	R-449A	R-449A	R-449A	R-449A
Maximum filling weight	kg	0.50	0.58	0.50	0.58

	Unit	VC 1200	VC 2000	VC 1200 W	VC 2000 W
GWP _(100a) *	---	1397	1397	1397	1397
CO ₂ equivalent	t	0.70	0.81	0.70	0.81

Table 19

	Unit	VC 3000	VC 5000	VC 3000 W	VC 5000 W
Refrigerant	---	R-449A	R-449A	R-449A	R-449A
Maximum filling weight	kg	0.95	1.10	0.95	1.10
GWP _(100a) *	---	1397	1397	1397	1397
CO ₂ equivalent	t	1.33	1.54	1.33	1.54

Table 20

	Unit	VC 7000	VC 10000	VC 7000 W	VC 10000 W
Refrigerant	---	R-452A	R-452A	R-452A	R-452A
Maximum filling weight	kg	2.0	2.0	2.0	2.0
GWP _(100a) *	---	2140	2140	2140	2140
CO ₂ equivalent	t	4.28	4.28	4.28	4.28



Global Warming Potential (GWP), CO₂ comparison = 1.0

* Time frame 100 years - according to IPCC IV

11.4 Filling volume and characteristics of the pumps

Table 21

Device	Maximum/minimum filling volume	Pump connection	Drain tap
	L	---	---
VC 1200 (W)	15/8	G ¾ (15), ¾" hose nozzle	G ½"
VC 2000 (W)	15/8	G ¾ (15), ¾" hose nozzle	G ½"
VC 3000 (W)	33/20	G ¾ (15), ¾" hose nozzle	G ½"
VC 5000 (W)	33/20	G ¾ (15), ¾" hose nozzle	G ½"
VC 7000 (W)	64/48	G 1¼ (20), 1" hose nozzle	G ¾"
VC 10000 (W)	64/48	G 1¼ (20), 1" hose nozzle	G ¾"

Characteristics of the pump with different mains supplies

The pumps characteristics were determined using water as heat transfer liquid.

Table 22: Maximum flow pressure and maximum flow rate

Alternating current	VC 1200 (W)	VC 2000 (W)	VC 3000 (W)
230 V; 50 Hz	0.9 bar; 28 L/min 3.2 bar; 37 L/min 4.8 bar; 37 L/min	0.9 bar; 28 L/min 3.2 bar; 37 L/min 4.8 bar; 37 L/min	3.2 bar; 37 L/min 4.8 bar; 37 L/min
200 V; 50/60 Hz	0.9 bar; 28 L/min ¹ 3.2 bar; 37 L/min 4.8 bar; 37 L/min	0.9 bar; 28 L/min ¹ 3.2 bar; 37 L/min 4.8 bar; 37 L/min	3.2 bar; 37 L/min 4.8 bar; 37 L/min
208-220 V; 60 Hz	0.9 bar; 28 L/min 3.2 bar; 37 L/min 4.8 bar; 37 L/min	0.9 bar; 28 L/min 3.2 bar; 37 L/min 4.8 bar; 37 L/min	3.2 bar; 37 L/min 4.8 bar; 37 L/min

¹ Characteristics at 200 V; 60 Hz: 1.2 bar; 28 L/min

Three-phase current	VC 5000 (W)	VC 7000 (W)	VC 10000 (W)
400 V; 3/N/PE~50 Hz	3.2 bar; 37 L/min 4.8 bar; 37 L/min 5.0 bar; 60 L/min	3.2 bar; 37 L/min 4.8 bar; 37 L/min 5.0 bar; 60 L/min	3.2 bar; 37 L/min 4.8 bar; 37 L/min 5.0 bar; 60 L/min
208-220 V; 3/PE~60 Hz	3.2 bar; 37 L/min 4.8 bar; 37 L/min 5.0 bar; 60 L/min	3.2 bar; 37 L/min 4.8 bar; 37 L/min 5.0 bar; 60 L/min	3.2 bar; 37 L/min 4.8 bar; 37 L/min 5.0 bar; 60 L/min
200 V; 3/PE~50/60 Hz	3.2 bar; 37 L/min 4.8 bar; 37 L/min 5.0 bar; 60 L/min ²	3.2 bar; 37 L/min 4.8 bar; 37 L/min 5.0 bar; 60 L/min ²	3.2 bar; 37 L/min 4.8 bar; 37 L/min 5.0 bar; 60 L/min ²

² Characteristics at 200 V; 3/PE~50 Hz: 4.3 bar; 60 L/min

Characteristic curves of the pumps

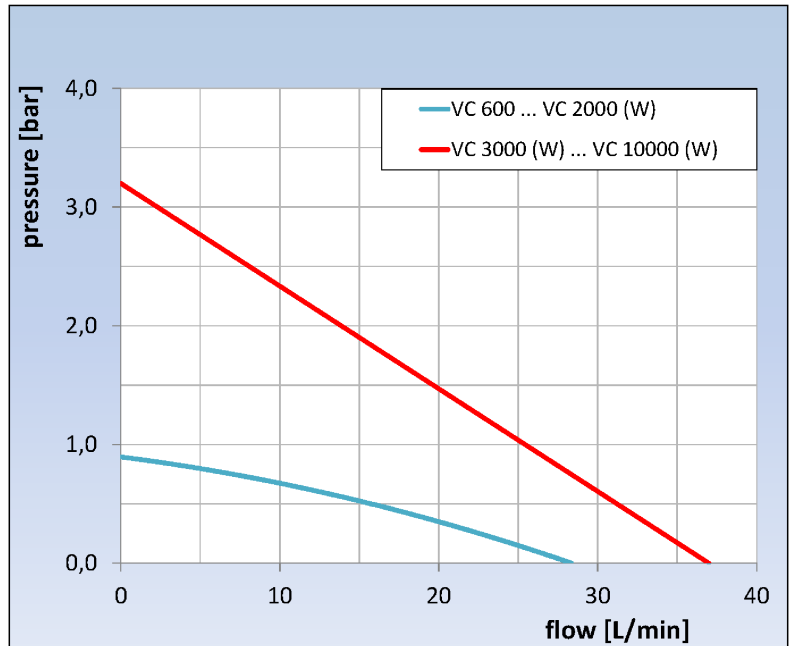

Fig. 70: Characteristic curves of the pumps

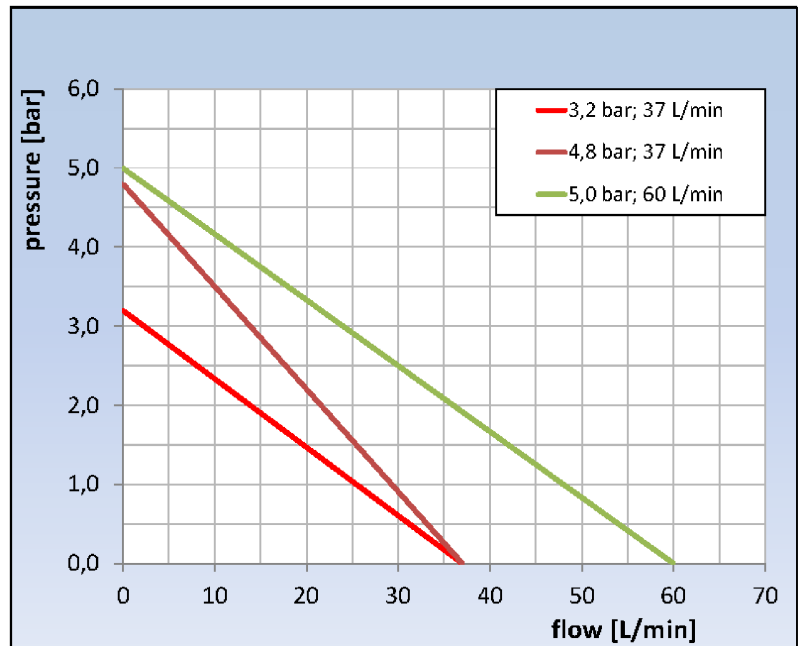

Fig. 71: Characteristic curves of the pumps

11.5 Heater

Table 23: Heating power and power consumption

Alternating current	VC 1200 (W)	VC 2000 (W)	VC 3000 (W)	Unit
230 V; 50 Hz				
Heating output	2.25	2.25	1.5	kW
Power consumption	3.3	3.3	2.6	kW
200 V; 50/60 Hz				
Heating output	1.7	1.7	1.1	kW
Power consumption	2.9	2.9	2.6	kW
208-220 V; 60 Hz				
Heating output	1.8 – 2.1	1.8 – 2.1	1.2 – 1.35	kW
Power consumption	3.1	3.2	2.8	kW

Table 24: Heating power and power consumption

Three-phase current	VC 5000 (W)	VC 7000 (W)	VC 10000 (W)	Unit
400 V; 3/N/PE~50 Hz				
Heating output	4.5	4.5	7.5	kW
Power consumption	7.8	8.8	11.1	kW
208-220 V; 3/PE~60 Hz				
Heating output	3.65 – 4.1	3.65 – 4.1	6.1 – 6.9	kW
Power consumption	4.5	5.7	7.7	kW
200 V; 3/PE~50/60 Hz				
Heating output	3.4	3.4	5.7	kW
Power consumption	4.3	5.4	7.6	kW

11.6 Potential equipment, voltage-independent

Product	Sound insulation	Outdoor installation	Insulation of the cooling water hydraulics
VC 5000	X	X	---
VC 7000	X	X	---
VC 10000	X	X	---
VC 1200 W	---	---	X
VC 2000 W	---	---	X
VC 3000 W	---	---	X

Product	Sound insulation	Outdoor installation	Insulation of the cooling water hydraulics
VC 5000 W	X	---	X
VC 7000 W	X	---	X
VC 10000 W	X	---	X

11.7 Mains fuse

Alternating current	VC 1200 (W)	VC 2000 (W)	VC 3000 (W)
230 V; 50 Hz	T16 A	T16 A	T16 A
200 V; 50/60 Hz	T16 A	T16 A	T16 A
208-220 V; 60 Hz	T16 A	T16 A	T16 A

Three-phase current	VC 5000 (W)	VC 7000 (W)	VC 10000 (W)
400 V; 3/N/PE~50 Hz	T16 A	T16 A	T16 A
208-220 V; 3/PE~60 Hz	T16 A	T20 A	T25 A
200 V; 3/PE~50/60 Hz	T16 A	T20 A	T25 A

12 Accessories

The following accessories are available for all Variocool devices.

Table 25: Large module bay 51 mm x 27 mm

Accessories	Catalogue number
Analog interface module	LRZ 912
RS 232/485-interface module Advanced	LRZ 926
Contact interface module Advanced with one input and one output	LRZ 927
Contact interface module Advanced with three inputs and three outputs	LRZ 928
Profibus interface module Advanced	LRZ 929

Table 26: Small module bay (51 mm x 17 mm)

Accessories	Catalogue number
External Pt100/LiBus module	LRZ 918
Command remote control unit (only functional in combination with LRZ 918)	LRT 927

Table 27: Connecting plug

Accessories	Catalogue number
External temperature probe with connector and shielded connection cable	ETP 059
6-pin coupling connector for analogue inputs/outputs	EQS 057
9-pin connecting plug SUB-D	EQM 042
RS 232 cable (length: 2 m) for PC	EKS 037
RS 232 cable (length:5 m) for PC	EKS 057
3-pin coupling connector for contact input	EQS 048
3-pin coupling socket for contact output	EQD 047

Table 28: Flow control instrument

Accessories	for device	Catalogue number
Flow control instrument G 3/4"	VC 1200 (W) – 5000 (W)	LWZ 118
Flow control instrument G 1 1/4"	VC 7000 (W) – 10000 (W)	LWZ 119

13 General

13.1 Copyright

This manual is protected by copyright and only meant for internal use by purchasers.

The relinquishment of this manual to third parties, copying in any way whatsoever – even in the form of excerpts – and the utilization and/or conveyance of its content are not allowed, except for internal purposes, without written approval from the manufacturer.

Violation of this may obligate the violator to the payment of damages. Other claims reserved.

We point out that the designations and brand names of the respective companies used in the manual are generally subject to trademark, brand and patent protection.

13.2 Technical changes

The manufacturer reserves the right to make technical modifications to the device.

13.3 Warranty conditions

LAUDA grants a standard warranty of one year.

13.4 Contact LAUDA

Contact the LAUDA Service department in the following cases:

- Troubleshooting
- Technical questions
- Ordering accessories and spare parts

Please contact our sales department for questions relating to your specific application.

Contact information

LAUDA Service

Phone: +49 (0)9343 503-350

Email: service@lauda.de

13.5 Declaration of Conformity



EC DECLARATION OF CONFORMITY

Manufacturer: LAUDA DR. R. WOBSEER GMBH & CO. KG
Laudaplatz 1, 97922 Lauda-Königshofen Germany

We hereby declare under our sole responsibility that the machines described below

Product Line: Variocool **Serial number:** from S210000001

Types: VC 1200, VC 1200 W, VC 2000, VC 2000 W, VC 3000, VC 3000 W,
VC 5000, VC 5000 W, VC 7000, VC 7000 W, VC 10000, VC 10000 W

comply with all relevant provisions of the EC Directives listed below due to their design and type of construction in the version brought on the market by us:

Machinery Directive	2006/42/EC
EMC Directive	2014/30/EU
RoHS Directive	2011/65/EU In connection with (EU) 2015/863

The equipment is not covered by the Pressure Equipment Directive 2014/68/EU, as the maximum classification of the equipment is Category 1 and it is covered by the Machinery Directive.

The protective objectives of the Machinery Directive with regard to electrical safety are complied with in accordance with Annex I Paragraph 1.5.1 in conformity with the Low Voltage Directive 2014/35/EU.

Applied standards:

- EN 12100:2011 (ISO 12100:2010)
- EN 61326-1:2013 (IEC 61326-1:2012)
- EN 378-2:2018
- EN 61010-1:2011 (IEC 61010-1:2010 + Cor. :2011)
- EN 61010-2-010:2015-05

Authorized representative for the composition of the technical documentation:

Dr. Jürgen Dirscherl, Director Research & Development

Lauda-Königshofen, 23.09.2021

Dr. Alexander Dinger, Head of Quality Management

*FAHRENHEIT. °CELSIUS. °LAUDA.

Document number: Q5WA-QA13-006-EN Version 06

13.6 Product Returns and Clearance Declaration

Product Returns

Would you like to return a LAUDA product you have purchased to LAUDA? For the return of goods, e.g. for repair or due to a complaint, you will need the approval of LAUDA in the form of a *Return Material Authorization (RMA)* or *processing number*. You can obtain the RMA number from our customer service department at +49 (0) 9343 503 350 or by email service@lauda.de.

Return address

LAUDA DR. R. WOBSE GMBH & CO. KG

Laudaplatz 1

97922 Lauda-Königshofen

Deutschland/Germany

Clearly label your shipment with the RMA number. Please also enclose this fully completed declaration.

RMA number	Product serial number
Customer/operator	Contact name
Contact email	Contact telephone
Zip code	Place
Street & house number	
Additional explanations	

Clearance Declaration

The customer/operator hereby confirms that the product returned under the above-mentioned RMA number has been carefully emptied and cleaned, that any connections have been sealed to the farthest possible extent, and that there are no explosive, flammable, environmentally hazardous, biohazardous, toxic, radioactive or other hazardous substances in or on the product.

Place, date	Name in block letters	Signature

14 Index

A	
Accessories	
In series	13
Interfaces	90
Optional (interfaces)	90
Actual bath temperature (display)	39
Adapting control parameters	
External	50
Adjustment time	50
Air-cooled	
Cleaning condenser	70
Alarm	73
Codes	73
Low Level	74
Overtemperature	75
Alarm output	
Setting	56
Application	
connect	26
Arrow buttons (position)	18
Attenuation time	50
Autostart	
Activating	55
Deactivating	55
B	
Basic window	
Normal operation	39
Standby operation	39
Structure	39
C	
Calibration (internal actual temperature)	
Reset	58
Specifying	57
Checking	
Heat transfer liquid	72
Low Level	70
Cleaning	69
CO ₂ equivalent	85
Code	
Alarms	73
Warnings (control system)	75
Warnings (safety system)	76
Warnings (SmartCool)	77
Condenser	18
Consumer	
connect	26
Contact	91
Control	
Warnings	75
Control menu	49
Control parameter	
Defining correction limitation	52
External (overview)	52
Control parameters	
Access	49
Adjusting (external)	52
Adjusting (internal)	51
Internal (overview)	50
Cooling unit	
Description	18
Function	19
Setting	45
Cooling water	
Connection information	27
Pressure	27
Requirements	26
Temperature	27
Copyright	91
Correction limitation	52
D	
Damping time	52
Defining limit values (temperature)	44
Defining temperature limit values	44
Defining the setpoint temperature	44
Descaling	71
Device	
Cleaning	69

Cleaning condenser (air-cooled)	70	Establishing power supply	31
Displaying serial numbers	61	Evaporator	18
Disposal (packaging)	81	Expanded status display (display)	39
Disposal (refrigerant)	81	External consuming unit	
Draining	79	connect	26
Draining the condenser (water-cooled)	80	External control	
Filling	34	Activating	45
Placement	23	Specifying the set point offset	46
Read out memory	60	F	
Request data	60	Factory Setting	
Retrieving status	58, 59	Restore	58, 59
Structure	16	Factory settings (internal actual temperature)	
Switching on	39	Restoring	58
Unpacking	13	Fill level alarm level	55
Display		Filler nozzle (position)	16
Actual bath temperature	39	Filling	34
Basic window (set-up)	39	Flow pressure	86
Expanded status display (set-up)	39	Flow rate	86
Soft key bar	39	G	
Status display (set-up)	39	Gain factor	52
Display buttons		GWP	85
Operation	18	H	
Displaying serial numbers (device)	61	Heat transfer liquid	
Disposal		Checking	72
Packaging	81	Overview (approved)	30
Refrigerant	81	Removing	79
Disposing of refrigerant	81	Hold-back time	50
Drain tap (position)	17	Hose clips	25
Draining		Hoses	25
Condenser (water-cooled)	80	I	
Device	79	Input button (position)	18
Draining nozzle (position)	17	Insulation	88
E		Intended Use	8
EMC	9	Interfaces	
Entry window		Overview	21
Inputting value	42	Interfaces (position)	16
Selecting options	42	K	
Structure	42	Kpe	52
Error	73		
Read out memory	60		
Errors	73		

L		
Lead time	52	
Limiting current consumption	55	
Lock		
Buttons	42	
Lock the entry functions	42	
Lock the operating button	42	
Low Level		
Alarm	74	
Checking	70	
M		
Main menu		
Access	41	
Navigation	41	
Structure	41	
Mains power (connection)	31	
Mains switch		
Operation	17	
Mains switch (position)	16	
Maintenance		
Intervals	68	
Menu		
Navigation	41	
Menu language	33	
Module		
Installing	29	
O		
Offset (internal actual temperature)		
Calibration	57	
Reset	58	
OUT		
Contact	56	
Outdoor installation	88	
Overtemperature switch-off point		
Alarm	75	
P		
Packaging		
Disposal	81	
Personal protective equipment (overview)	11	
Personnel qualification (overview)	11	
Placement (device)	23	
Placement site	23	
Pressure gauge	18	
Program		
Access	64	
Create	65	
Defining loops	67	
Defining repetitions	67	
Edit	65	
Editing	65	
End	67	
Example	61	
Interrupt	67	
Segment	65	
Select	64	
Start	67	
Prop_E	52	
Proportional range	50, 52	
Protective equipment (personal, overview)	11	
Pump		
Connection socket (position)	17	
Higher performance	21	
Pump characteristic curve	88	
R		
Read out memory (error)	60	
Refrigerant		
Filling charge	85	
Filling weight	85	
Fluorinated	10	
Request configuration data (device)	60	
Reset time	52	
Retrieving status (device)	58, 59	
S		
Safety notice		
General	7	
Safety system (warnings)	76	
Segments	65	
Service	91	
Setting brightness (display)	54	
Setting display brightness	54	

Setting volume (sounds)	53	V	
SmartCool (warnings)	77	Version (software)	60
Soft key bar (display)	39	W	
Soft keys (Position)	18	Warning	
Software version	60	Control system	75
Sounds	53	Safety system	76
Specifying language (display)	57	SmartCool	77
Specifying menu language	57	Warnings	73
Specifying starting mode	55	Warranty	91
Specifying the setpoint	44	Water-cooled	
Standby		Condenser draining	80
Activating	44	X	
Status display (display)	39	Xp	50
Structure		Xpf	52
Device	16		
Submenu			
Access	41		
Navigation	41		
Switching on	39		
T			
Td	50		
Tde	52		
Technical data			
Pump characteristic curve	88		
Technical Data			
Flow pressure	86		
Flow rate	86		
Three-phase motor			
Direction of rotation	31		
Tih	43		
Til	43		
Tn	50		
Tne	52		
Tolerance range	61		
Tv	50		
Tve	52		
Type plate (position)	17		
U			
Unpacking	13		

LAUDA DR. R. WOBSE GMBH & CO. KG
Laudaplatz 1 ° 97922 Lauda-Königshofen ° Germany
Telephone: +49 (0)9343 503-0
E-mail: info@lauda.de ° Internet: <https://www.lauda.de>