

Operation manual

ECO GOLD

Heating and cooling thermostats with control head GOLD

Immersion thermostat

ECO GOLD

Heating thermostats

E 4 G, E 10 G, E 20 G, E 25 G, E 40 G, ET 6 G, ET 12 G, ET 15 G, ET 20 G

Cooling thermostats with natural refrigerant

RE 415 G, RE 420 G, RE 630 G, RE 1225 G, RE 2025 G, RE 1050 G

Calibration thermostat with natural refrigerant

RE J 1225 G

Manufacturer
LAUDA DR. R. WOBSER GMBH & CO. KG
Laudaplatz 1
97922 Lauda-Königshofen
Germany
Phone: +49 (0)9343 503-0
Fax: +49 (0)9343 503-222
E-mail info@lauda.de
Internet <http://www.lauda.de>

Translation of the original operation manual Q4DA-E_13-029
replaces version 10/2019 h, 05/2019 g, 11/2018 f, 05/2017 e, 11/2016 d1, 08/2016 a2,
08/2011 a1

Valid from:

Software of Control System version 1.54
Software of Safety System version 1.43
Software of Chilling System version 1.37
Software Analog IO module version 3.21
Software Serial IO RS 232 module version 3.22
Software Digital IO module version 3.14
Software Solenoid valve version 3.06
Software EtherCAT module version 1.08
Software Ethernet module version 1.23

Table of contents

1	Safety	7
1.1	Safety information	7
1.2	General safety	8
1.3	Special safety information	9
2	General remarks	11
2.1	Description of the device	11
2.2	Intended application.....	11
2.3	Use other than that intended.....	11
2.4	Responsibility of the operating body - safety information	11
2.5	Materials	12
3	Device description	13
3.1	Device types	13
3.2	Pump.....	13
3.3	Programmer	13
3.4	Interfaces.....	13
3.5	Interface modules (Accessories)	14
3.6	Chiller.....	14
4	Operating and functional controls	16
5	Transport and unpacking	22
6	Before putting the device into operation	24
6.1	Assembly and siting.....	24
6.2	Connection of external consumers	31
6.3	Filling and emptying	34
6.4	Heat transfer liquids, cooling water and hoses	36
6.5	Cooling of heating thermostats	40
6.6	First switch-on	40
6.7	Installation of modules.....	41
7	Operation	43
7.1	Switching on	46
7.2	Menu structure	47
7.3	Display representation.....	49
7.3.1	<i>Basic window</i>	49
7.3.2	<i>Menu window</i>	49
7.3.3	<i>Entry window</i>	50
7.3.4	<i>Graphics window</i>	51
7.4	Basic setup.....	51

7.4.1	Setting the overtemperature switch-off point T_{max}	51
7.4.2	Setting the temperature set-point value.....	52
7.4.3	Setting the pump level.....	52
7.4.4	Activating the "Standby" operating state.....	53
7.4.5	Defining temperature limits.....	53
7.4.6	Setting the date and time.....	54
7.4.7	Selecting the menu language.....	54
8	Maintenance.....	55
8.1	Alarms, warnings and errors.....	55
8.1.1	Overtemperature protection: Alarm and checking.....	55
8.1.2	Low level: Alarm and checking.....	56
8.2	Device status.....	57
8.2.1	Store for errors, alarms and warnings.....	57
8.2.2	Device data.....	57
8.2.3	Software version.....	58
8.2.4	Displaying and changing the device type.....	58
8.2.5	Displaying serial numbers.....	58
8.3	Servicing.....	59
8.3.1	Cleaning.....	59
8.3.2	Servicing intervals.....	60
8.3.3	Inspecting the heat transfer liquid.....	60
8.3.4	Cleaning the condenser.....	61
8.4	Fault finding.....	62
8.5	Disposal information.....	63
8.5.1	Disposal of the refrigerant.....	63
8.5.2	Disposal of the packaging.....	63
8.6	Taking the device out of service.....	64
8.7	Ordering replacement parts / LAUDA Service.....	65
9	Accessories.....	66
10	Technical data and graphs.....	68
11	Declaration of Conformity.....	76
12	Index.....	78
Appendix with settings.....		83
13	Other settings.....	84
13.1	Resetting to factory settings.....	84
13.2	Setting the volume of the acoustic signals.....	85
13.3	Setting the chiller.....	85
13.4	Setting the display brightness.....	86

13.5	Defining the starting mode (Autostart)	86
13.6	Limiting the mains current consumption	87
13.7	Entering the offset of the displayed temperature (calibration)	87
13.8	Restoring the factory setting of the internal temperature sensor	88
13.9	Key lock.....	89
14	List of "Alarm and warning codes".....	90
15	Graphical display of temperature measurements.....	93
16	External control	96
16.1	Activating external control (external Pt100)	96
16.2	Show the selected control variable (external temperature) on the display	96
16.3	Setpoint offset operating mode (Diff.set/actual)	97
17	Programmer	98
17.1	Programming example.....	98
17.2	Creating and editing a program	100
17.3	Starting the program.....	102
17.4	Interrupting, continuing or terminating the program.....	102
17.5	Defining the number of program loops (Loops).....	103
18	Control parameters	104
18.1	Internal control variable (internal temperature sensor)	104
18.2	External control variable	106
18.2.1	<i>Setting the correcting quantity limit.....</i>	<i>107</i>
18.2.2	<i>Procedure for setting the control parameters for external control.....</i>	<i>108</i>
19	Interface modules	109
19.1	Menu structure of the modules	109
19.2	Analog module.....	110
19.3	RS 232/485 interface module.....	111
19.3.1	<i>Connecting lead and interface test RS 232</i>	<i>111</i>
19.3.2	<i>RS 232 protocol.....</i>	<i>112</i>
19.3.3	<i>RS 485 connecting lead</i>	<i>112</i>
19.3.4	<i>RS 485 protocol.....</i>	<i>113</i>
19.4	LiBus module	113
19.5	Pt100/LiBus module.....	114
19.6	USB interface.....	115
19.6.1	<i>Description</i>	<i>115</i>
19.6.2	<i>Installation of the USB driver.....</i>	<i>115</i>
19.6.3	<i>Connecting the thermostat to the PC.....</i>	<i>116</i>
19.6.4	<i>Where is the ECO Virtual COM Port?.....</i>	<i>118</i>
19.7	Commands and error messages applicable to the RS 232/485 interface module and to the Ethernet interface	120

19.7.1	Interface write commands (data issued to the thermostat).....	120
19.7.2	Interface read commands.....	121
19.7.3	Interface error messages.....	124
19.7.4	Driver software for LABVIEW®.....	124
19.8	Contact module.....	125
19.8.1	Contact module LRZ 914 with 1 input and 1 output.....	125
19.8.2	Contact module LRZ 915 with 3 inputs and 3 outputs.....	126

1 Safety

1.1 Safety information



Type and source
<i>Consequences of non-compliance</i>
<ul style="list-style-type: none"> Action 1 Action ...

"DANGER" indicates an immediate dangerous situation which – if the safety requirements are ignored – may result in fatal or severe, irreversible injuries.



Type and source
<i>Consequences of non-compliance</i>
<ul style="list-style-type: none"> Action 1 Action ...

"WARNING" indicates a possible dangerous situation which – if the safety requirements are ignored – may result in fatal or severe, irreversible injuries.



Type and source
<i>Consequences of non-compliance</i>
<ul style="list-style-type: none"> Action 1 Action ...

"CAUTION" indicates a possible dangerous situation which – if the safety requirements are ignored – may result in slight, reversible injuries.

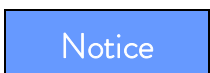

Type and source
<i>Consequences of non-compliance</i>
<ul style="list-style-type: none"> Action 1 Action ...

"NOTICE" warns of possible property or environmental damage.



Reference

Refers to further information in other sections.

1.2 General safety

Read through the operating instructions carefully. They contain important information for working with this device. If you have any queries, please contact our Service Department (⇒ 8.7).

Follow all the directions in these operating instructions. Only in this way is the correct procedure ensured when working with the device.

- Make sure that the device is only operated by instructed specialist personnel.
- Never operate the device without heat transfer liquid.
- Never operate the device,
 - if it is damaged,
 - if it is leaking,
 - if the mains cable is damaged.
- Switch off the device and withdraw the mains plug:
 - when carrying out service or repair work,
 - when moving the device,
 - when installing or removing modules or accessories,
 - in case of danger.
- Do not make technical modifications to the device. Infringements in this respect invalidate the warranty.
- Have service and repair work carried out only by specialists.
- Follow the safety information in the following sections and read it through carefully.
- Due to national and international (security) regulations, the application and the transport of ECO devices with natural refrigerants is limited on the area of the EU, the United Kingdom (UK), Switzerland and to the related voltage variant 230 V; 50 Hz.

The devices are not designed for use in medical applications in accordance with DIN EN 60601-1 and IEC 601-1!

Classification in accordance with EMC requirements			
Device	Immunity requirements	Emissions Class	Customer power supply
Heating thermostat ECO Gold	Table 1* in accordance with DIN EN 61326-1	Emissions Class B in accordance with CISPR 11	Worldwide No limitation

Device	Immunity requirements	Emissions Class	Customer power supply
Cooling thermostat ECO Gold	Table 1* in accordance with DIN EN 61326-1	Emissions Class B in accordance with CISPR 11	Worldwide No limitation

* Devices for use in basic electromagnetic environment

Instructions for Class A digital device, USA:

“**Note:** This equipment has been tested and found to comply with the limits for Class A digital device, pursuant to Part 15 of the FCC (Federal Communication Commission) Rules. These limits are designed to provide reasonable protection against harmful interference when the equipment is operated in a commercial environment. This equipment generates, uses, and can radiate radio frequency energy and, if not installed and used in accordance with the instruction manual, may cause harmful interference to radio communications. Operation of this equipment in a residential area is likely to cause harmful interference in which case the user will be required to correct the interference at his own expense”.

Instructions for Class A digital device, Canada:

“This Class A digital apparatus complies with Canadian ICES-003” (ICES = Interference Causing Equipment Standards).

1.3 Special safety information

The use of the thermostat is only admissible under the following conditions:

- The siting surface must be impervious, flat, non-slip and non-combustible. Do not position the thermostat at the edge of the bench or table.
- Keep to the specified wall spacing (⇒ 6.1).
- Protect the thermostat from dripping or condensing water.
- Do not store any liquids or combustible objects above the device.
- Do not work with flammable liquids in the direct vicinity of the device.
- Only connect the device to an earthed mains socket which is freely accessible.
- At higher operating temperatures parts of the bath cover can take on temperatures of over 70 °C. There is a danger of burns.
- Only use suitable hoses. (⇒ 6.4)
- Ensure that the hoses are not kinked during operation.
- Check the hoses at certain inspection intervals (⇒ 8.3.2) for material fatigue.
- Hoses with hot heat transfer liquid and other hot parts must not come into contact with the mains cable.
- When using the thermostat as a circulation thermostat, hot liquid can escape due to hose fracture and become a danger to personnel and materials.
- Irritant vapors may be generated depending on the heat transfer liquid used and the operating mode.
 - Ensure sufficient extraction of the vapors.
 - Use the bath cover.
- Carefully mount the immersion thermostat on the bath vessel.
- Only use bath vessels which are suitable for the intended operating temperatures.
- When filling, set the overtemperature switch-off point according to the heat transfer liquid used.
- When changing the heat transfer liquid from water to other liquids for temperatures above 100 °C, carefully remove all residues of water including from the hoses and consumers, otherwise there is a risk of scalding due to delay in boiling.

To do this also remove the blank plugs on the pump inputs and outputs and blow them out with compressed air.

- Use the cooling coil with cooling water only at operating temperatures below 100 °C. At higher temperatures, there is danger of hot vapors forming.
- Have repairs carried out only by specialists.
- Keep to all the service and maintenance intervals (⇒ 8.3.2).
- Take note of all safety instructions on the device and in these operating instructions. .

Applicable to water-cooled devices:

- Secure the return hose of the water cooling in the discharge area in order to prevent the hose sliding off uncontrollably, also during pressure surges.
- Secure the return hose of the water cooling in the discharge area so that it is not possible of hot cooling water to splash out.
- Avoid kinking or crushing the return hose of the water cooling. Excessive pressure can cause the cooling water hoses to tear and hot water to escape.
- To avoid damage due to a leak in the cooling water system we recommend the use of a water leakage sensor with water cut-off.

In addition, the following applies to cooling devices with natural refrigerant:

- The natural refrigerant, propane R-290, is flammable and not odorized.
- With a leakage of the refrigerant circuit the following should be observed:
 - Do not operate any switch on the device nor at any other point in the room.
 - Do not produce any flames nor sparks.
 - Immediately ventilate the room and contact LAUDA Service Constant Temperature Equipment.
- Service valves and the refrigerant lines on the cooling water valve on water-cooled devices are identified with a yellow shrink-on sleeve with the warning "flammable".
- Comply with the minimum room size for the siting point according to DIN 378-2.
 - The following applies for the refrigerant propane R-290 with a filling quantity of:
 - 30 g --> min. 3.75 m³ room volume
 - 33 g --> min. 4.13 m³ room volume
 - 120 g --> min. 15.0 m³ room volume
 - The filling amount is given on the rating label.

2 General remarks

2.1 Description of the device

This device is a laboratory thermostat. It is obtainable as:

- Immersion thermostat (optionally with cooling coil), which is used for heating (and optionally for cooling) liquids in existing vessels.
- Heating bath and circulation thermostat, designated in the following as a heating thermostat, which is used for heating liquids.
- Heating bath and circulation thermostat (a cooling/heating thermostat), also designated in the following as a "cooling thermostat", which is used for cooling and heating liquids.

2.2 Intended application

This LAUDA thermostat is manufactured exclusively for cooling/heating liquid baths. In the case of the immersion thermostat the baths used must have methods of secure mounting.

- The device may only be put into operation in suitable interior rooms.
- Operation up to a height of 2000 m above sea level is admissible.

The devices must only be operated as intended and under the conditions stated in these operating instructions. Any other operating mode is not regarded as used as intended.

The thermostat may only be operated with the following heat transfer liquids:

- Aqua 90
- Kryo 20
- Kryo 30
- Kryo 51
- Therm 160
- Therm 180
- Therm 250
- Decalcified water

Take into account the properties of the heat transfer liquids. (⇒ 6.4)

2.3 Use other than that intended

The device must not be used:

- in areas subject to explosion hazards
- when sited outdoors
- with combustible or highly flammable gases
- for heating or cooling foodstuffs

2.4 Responsibility of the operating body - safety information

The operating body is responsible for the qualifications of the operating personnel.

- The thermostat must only be configured, installed, maintained and repaired by specialist personnel.
- Persons operating the device must be instructed in their work by a specialist.
- Make sure that specialist personnel and operators have read and understood the operating instructions.
- The device must be used as intended (⇒ 2.2).

2.5 Materials

All parts that are exposed to heat transfer liquid are manufactured from high-quality materials adapted to withstand the operating temperature. High-quality stainless steel, brass, bronze, high-quality heat-resistant plastics and elastomers are used.

3 Device description

3.1 Device types

Heating thermostats

The type designation of the LAUDA heating thermostats is composed of the prefix E for ECO, the approximate bath volume in liters and a G for the GOLD device variant.

Example: E 10 G is a heating thermostat with a maximum bath volume of 10 liters in the GOLD device variant.

With the heating thermostats with a transparent bath there is the prefix of ET for the ECO transparent bath, followed by the bath volume in liters and a G for the device variant GOLD.

Example: E 6 G is a heating thermostat with a transparent bath with a maximum bath volume of 6 liters in the GOLD device variant.

Cooling thermostats

The type designation of LAUDA cooling thermostats is composed of the prefix R (to identify the cooling thermostat: Refrigerated), an E for ECO, the bath volume in liters, the minimum attainable temperature (without arithmetical sign) and a G for the device variant GOLD.

Example: RE 420 G is a heating thermostat with a maximum bath volume of 4 liters and a minimum temperature of -20 °C. Where applicable the type designations are supplemented by a W for "water-cooled".

3.2 Pump

All devices are equipped with a pressure pump. The pump has an output with a pivotable outflow elbow. An additional output is used for internal bath circulation. By switching the selector at the front on the control head, the flow can be manually selected or divided between the two outputs.

Using the operating menu, one of six flow-rate levels can be selected for the pump. For thermostats with a small bath a power level of 1 to 3 is practicable.

When operated as a circulation thermostat with an external consumer, a higher power level is practicable to keep the temperature difference between the bath and external consumer small even at higher temperatures.

The pump connection of the outflow can be closed without any detrimental effects on the pump.

Pump characteristics (⇒ 10)

3.3 Programmer

The devices are equipped with a programming function (⇒ 17).

3.4 Interfaces

In the basic version the devices are equipped with a USB interface. This enables, for example, the connection of a PC and operation with the thermostat control software "Wintherm Plus". In addition software updates are possible via the USB interface. The connecting lead is not included in the items supplied with the thermostat. When connecting up, make sure the correct plug is used.

3.5 Interface modules (Accessories)

The devices can be supplemented with further interface modules, which are connected to the rear of the control head in two module slots (⇒ 6.7) and are inserted.

The following modules are currently available:

1. **Analogue Module** (LAUDA catalogue no. LRZ 912) with two inputs and two outputs on a six-pole DIN socket. The inputs and outputs can be set independently of one another as a 0 - 20 mA, 4 - 20 mA or 0 - 10 V interface, 20 V is brought out on the socket as a power supply for an external sensor with evaluation electronics.
2. **RS 232/485 Interface Module** (LAUDA catalogue no. LRZ 913) with nine-pole SUB-D socket. Electrically isolated using optocouplers. Using the LAUDA instruction set, extensively compatible to the ECO, Proline, Proline Kryomat, Integral XT and Integral T series. The RS 232 interface can be connected using a 1:1 contacted cable (LAUDA catalogue no. EKS 037) directly to the PC.
3. **Contact Module** (LAUDA catalogue no. LRZ 914) with connector to NAMUR NE28. Range of functions as for LRZ 915, but only one output and one input on each of two DIN sockets. Coupling socket, 3-pole (LAUDA catalogue no. EQD 047) and coupling plug 3-pole (LAUDA catalogue no. EQS 048).
4. **Contact Module** (LAUDA catalogue no. LRZ 915) on a 15-pole SUB-D socket. With three relay contact outputs (changeover, max. 30V/0.2A) and three binary inputs for control via external voltage-free contacts. Plug 15-pole, (LAUDA catalogue no. EQM 030) and Plug Housing (LAUDA catalogue no. EQG 017).
5. **Profibus Module** (LAUDA catalogue no. LRZ 917).
You will find further information in the Operating Instructions Q4DA-E_13-014 for the Profibus Module.
6. **Pt100/LiBus Module** (LAUDA catalogue no. LRZ 918)

External Pt100: For the connection of an external temperature sensor.

LiBus: For the connection of the Command remote control unit from the Proline equipment line and other accessories, such as a solenoid valve for cooling water control or a reverse-flow protection device.

3.6 Chiller

The chiller mainly consists of a fully hermetically sealed compressor. The dissipation of the condensation and motor heat takes place via a fan-ventilated lamellar condenser for water-cooled devices via heat exchanger. Here, atmospheric air is drawn in at the front of the device, heated up and discharged at the back and sides. To ensure proper air circulation the ventilation openings must not be covered up.

The compressor is equipped with a thermal release which responds to the compressor temperature and current consumption. The chiller is normally switched in automatically, but can also be switched in manually via the operating menu (⇒ 13.3).

The chiller is switched off when a malfunction occurs which affects safety.

The Cooling Thermostat RE 1050 G is equipped with the SmartCool technology which makes optimum use of the compressor and only chills when cooling output is demanded by the controller. To achieve this, several sensors in the cooling circuit monitor the operating status.

Cooling times for the various cooling thermostats can be taken from the **cooling curves** (⇒ 10).

4 Operating and functional controls

On the following pages the ECO GOLD control head, the control panel and the heating/cooling thermostat device types are presented.

Control Head ECO GOLD (can be used as immersion thermostat with screw clamp)

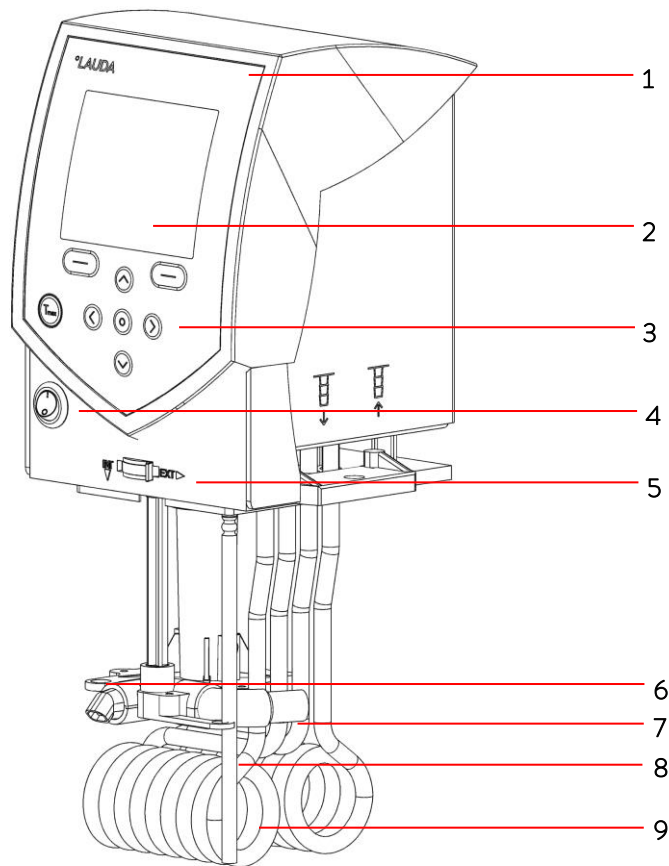

- 1 Light sensor for automatic control of display brightness
- 2 Color TFT display
- 3 Control panel (refer to following page)
- 4 Mains switch
- 5 Selector switch for dividing up the external and internal pump flow
- 6 Pump output for internal bath circulation
- 7 Pump output for bath circulation or connection to the pump connection set
- 8 Pt100 temperature sensor
- 9 Heater

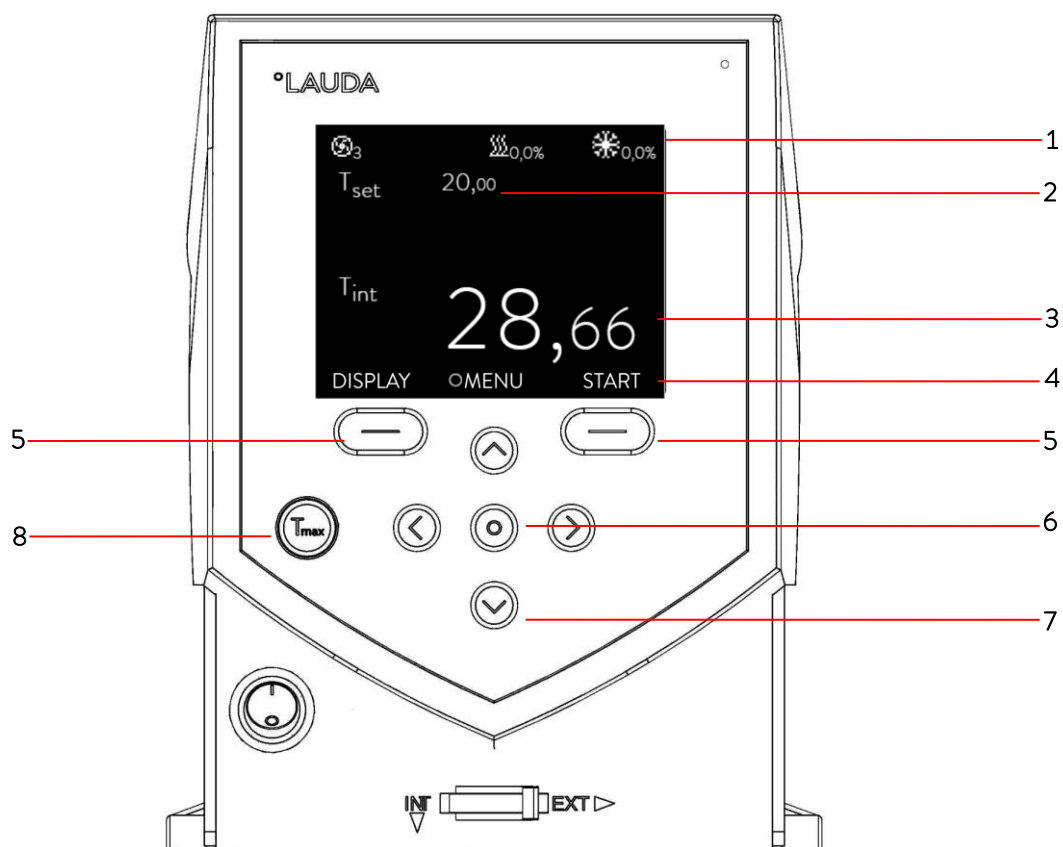

Display

- 1 Expanded status display
- 2 Status display
- 3 Display of the internal or external temperature value (T_{int} or T_{ext})
- 4 Soft-key bar

Control panel

- 5 Soft keys, left and right
- 6 Enter key
- 7 Cursor keys for Up, Down, Left and Right
- 8 Key T_{max} : Display and adjustment of the over-temperature switch-off point

Rear view of Control Head ECO GOLD

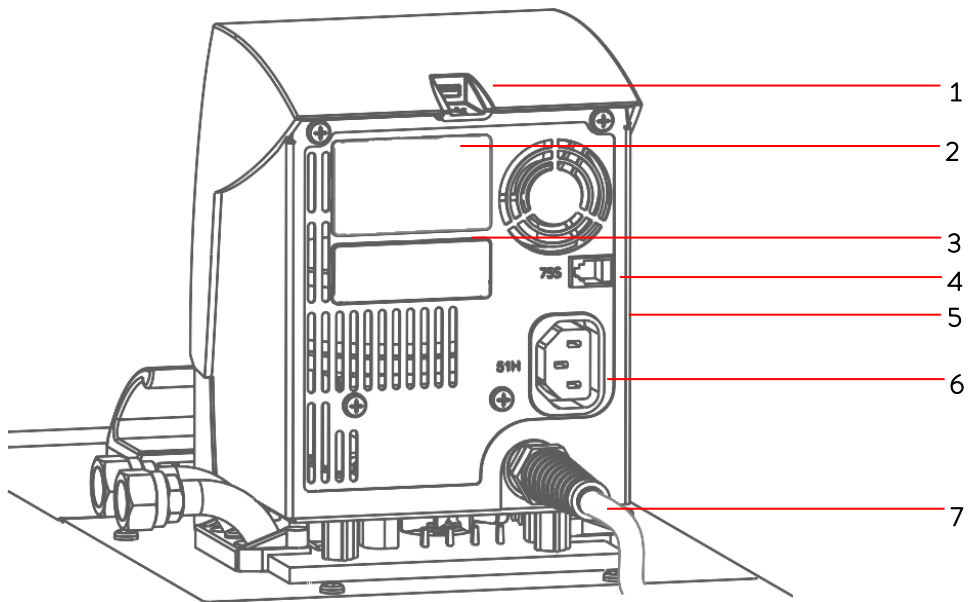

- 1 USB interface
- 2 Upper module receptacle approx. 51 mm x 27 mm for analogue, RS 232/485 module, Profibus module and contact modules.
- 3 Lower module receptacle approx. 51 mm x 17 mm for Pt100/LiBus module
- 4 Connection 75S for control cable of cooling underpart for RE 1050 G
- 5 Rating label
- 6 Connection socket 51H for power supply between the control head and cooling underpart
- 7 Mains connecting lead

Heating Thermostats ECO GOLD

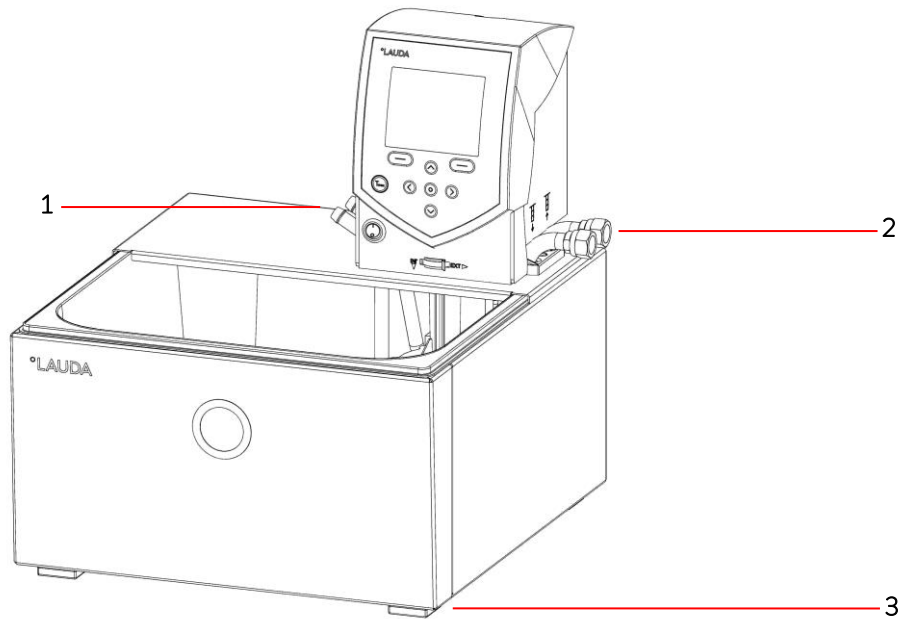

- 1 Cooling coil connections
- 2 Pump connection: outflow and return (as standard only with E 4 G and ET 15 G)
- 3 Four feet

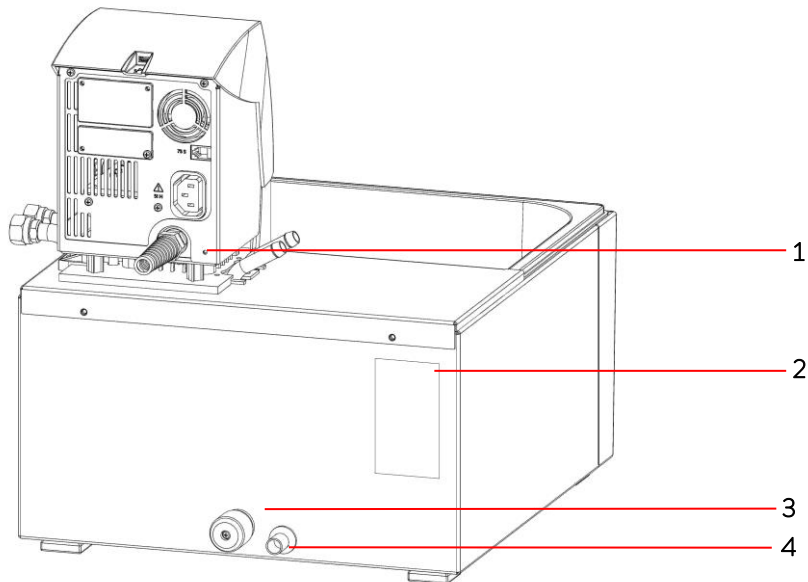

- 1 Mains connecting lead
- 2 Rating label
- 3 Bath draining tap
- 4 Bath drain point

Cooling Thermostats ECO GOLD

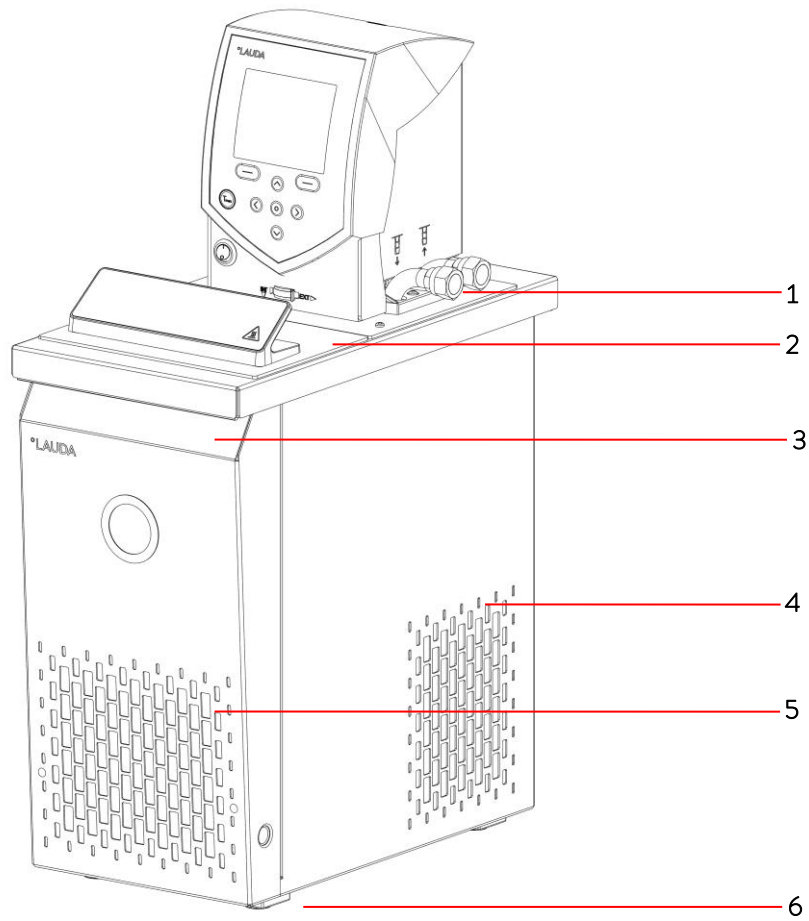

- 1 Pump connection: Outflow and return with M16 x 1 thread (stainless steel)
- 2 Bath cover
- 3 Front grip recess
- 4 Ventilation grill (both sides)
- 5 Front panel (removable without tools)
- 6 Four feet

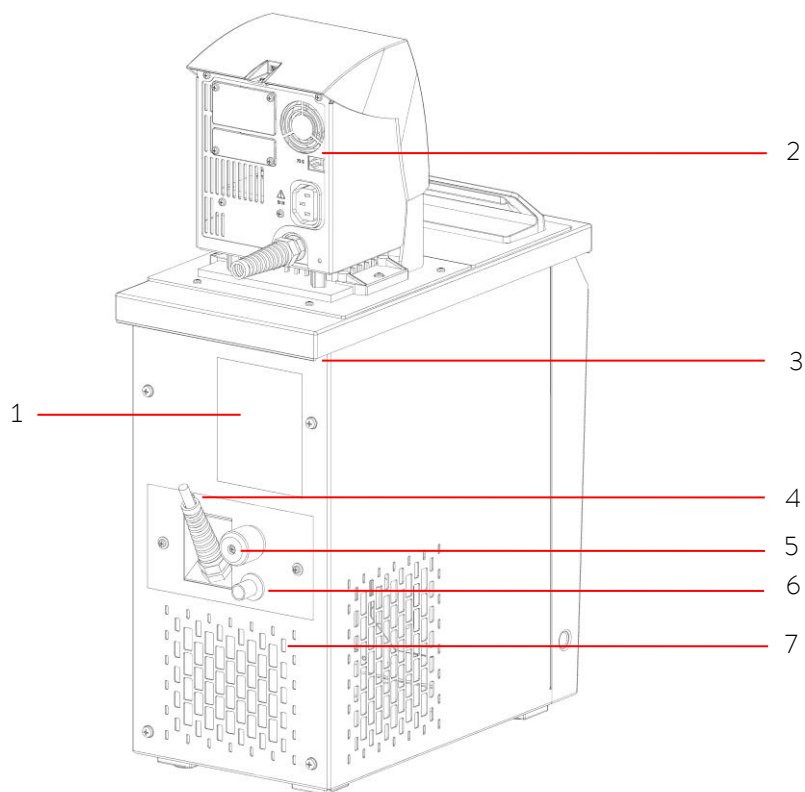

- 1 Rating label
- 2 Control cable between the control head and cooling underpart (only with RE 1050 G)
- 3 Rear grip recess
- 4 Connecting lead between the control head and cooling underpart
- 5 Bath draining tap
- 6 Bath drain point
- 7 Ventilation grill

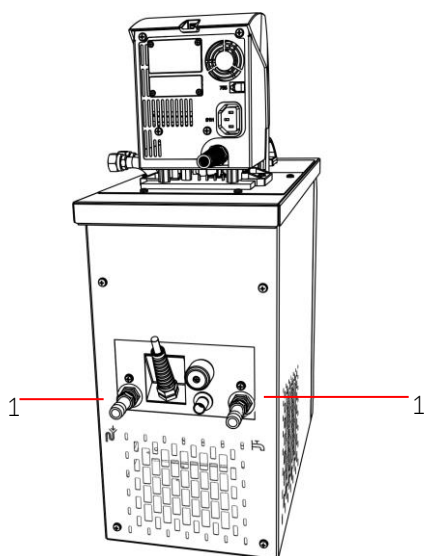

- 1 Connections for water cooling

5 Transport and unpacking

Keep your original packing of your thermostat for later transport.



Shipping damage
<i>Electric shock hazard</i>
<ul style="list-style-type: none"> • Check the device carefully for shipping damage before putting into operation. • Never operate the device if you have found shipping damage.



Falling / toppling equipment
<i>Crushing of hands and feet, impacts</i>
<ul style="list-style-type: none"> • Use the handles. (With heating thermostats grasp the device underneath) • Site the device only on a level surface.

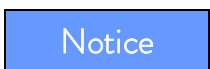

Falling / toppling equipment
<i>Property damage</i>
<ul style="list-style-type: none"> • Do not tilt the cooling device during transport and never turn it upside down.

Also note the following for cooling devices with natural refrigerant:





Danger of overpressure due to a too high ambient temperature at standstill
<i>Emission of refrigerant and injury due to explosion</i>
<ul style="list-style-type: none"> • Note the admissible storage and operating temperatures.

Check the device and the accessories immediately after shipment for completeness and shipping damage. If contrary to expectations the device or accessories are found to be damaged, inform the shipping company immediately so that a report can be produced and the shipping damage examined.

Also, immediately inform **LAUDA Service** (⇒ 8.7).

Standard accessories:

Catalogue number	Quantity	Description	Included with thermostat
HDQ 168	1	Bath Cover E 4	E 4 G
HDQ 163	1	Bath Cover RE 415, RE 420	RE 415 G and RE 420 G
HDQ 164	1	Bath Cover RE 620, RE 630	RE 630 G
HDQ 165	1	Bath Cover RE 1050	RE 1050 G
HDQ 166	1	Bath Cover RE 1225	RE 1225 G
HDQ 167	1	Bath Cover RE 2025	RE 2025 G
LCZ 0717	1	Pump Connection Set	Cooling thermostats, E 4 G, ET 15 G
HKO 026	2	Hose Nozzle Ø 13 mm	Cooling thermostats, E 4 G, ET 15 G
HKM 032	2	Cap Nut M16 x 1	Cooling thermostats, E 4 G, ET 15 G
HKN 065	2	Closing Plug	Cooling thermostats, E 4 G, ET 15 G
LCZ 0720	1	Cooling Coil	RE (cooling) devices, E 4 G, ET 6 G
LCZ 0721	1	Cooling Coil	E 10 G, E 20 G, E 25 G, E 40 G, ET 12 G, ET 20 G
EZB 260	1	Warning Label "HOT" 	All thermostats Note: With applications above 70 °C attach the warning label at an easily visible point.
EZB 792	1	Warning label "FLAMMABLE" 	Cooling thermostats with natural refrigerant
Q4DA-E_13-029	1	Operation manual	All thermostats

6 Before putting the device into operation

Please note:

- The device can be operated up to an ambient temperature of 40 °C.
- A higher ambient temperature can have a negative effect on the cooling output of the thermostats used.
- When putting the chiller into operation after a lengthy shut-down, up to 30 minutes may pass until the rated refrigerating power is available depending on room temperature and device type.

6.1 Assembly and siting

Always comply with the following safety information:



Falling / toppling equipment on sloping surfaces / table edge
<i>Crushing of hands and feet</i>
<ul style="list-style-type: none">• Only site the device on flat surfaces, not near the edge of the bench or table.

Also note the following for cooling devices with natural refrigerant:



Explosive gas mixture when leaking
<i>Injury, explosion</i>
<ul style="list-style-type: none">• Note the required size of the siting room.• Minimum room volume 1 m³ per 8 g of propane R-290

Affix the symbol "Hot surface".

The ECO thermostat is used as:

- Immersion thermostat (optionally with cooling coil and/or pump connection set),
- Heating thermostat (heating bath and circulation thermostat),
- Cooling thermostat (cooling/heating bath and circulation thermostat).

Assembly as immersion thermostat

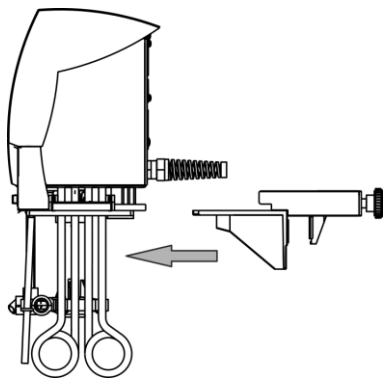

- Push the screw clamp on the underside of the control head into the guide rails.
- Insert the thermostat with the screw clamp into the temperature control vessel (⇒ 9) and screw the clamp tightly to the bath edge with the knurled screw.
- With plastic baths the tubular heating element must not contact the bath wall.
- Ensure that the ventilation opening at the back of the device is free.
- Keep a distance of at least 20 cm free on all sides of the device.



Control head drops into bath
<i>Electric shock hazard</i>
<ul style="list-style-type: none"> • Make sure that the control head mounting is securely joined to the bath.

Operation with cooling coil

For the optional operation with the cooling coil (LCZ 0720 and LCZ 0721) mount the cooling coil as follows:

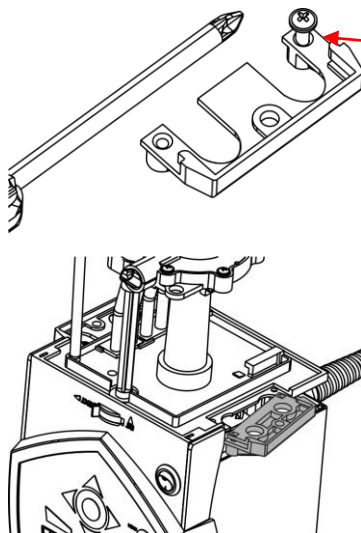

Cut the thread with the enclosed screw

- Cut the thread on the holed flange already before assembly.

The cooling coil can only be mounted on one side of the control head. This is located on the side with the mains switch.

- Withdraw the mains plug.
- Use a soft underlay to avoid scratches to the upper side of the control head.
- To fit the cooling coil loosen the two cross-head screws on the blind flange and remove it (see illustration).

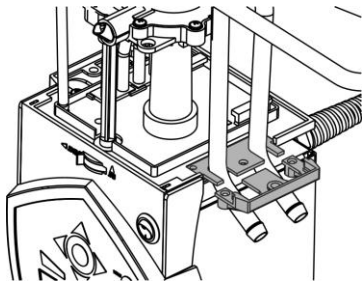

- Place the flange of the cooling coil in the position of the removed blind flange and push the holed flange underneath it.



Holed flange

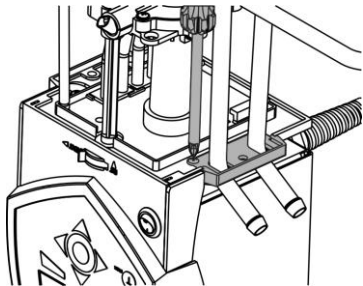

- With the two cross-head screws, mount the carrier plate of the cooling coil and the holed flange to the underside of the control head.

Please note: Use the cooling coil with cooling water only at operating temperatures below 100 °C.
At higher temperatures there is danger of hot steam forming.

For operation with an external consumer follow the connection instructions (⇒ 6.2).

Assembly as immersion thermostat

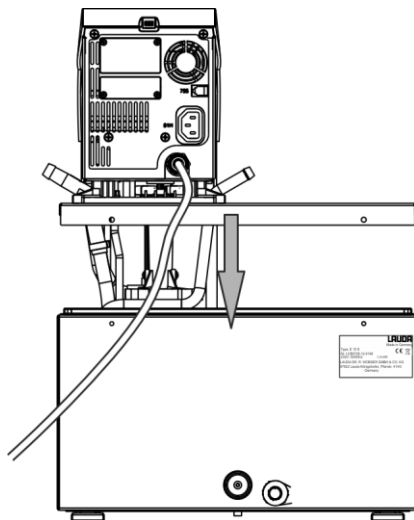

- Place the bath vessel on a flat surface.
- The control head is already screwed to the bath bridge.
In the rear part of the bath there are two slots present on the bath edge. Guide the prongs of the bath bridge into the slots to the right and left from the rear of the bath. Place the bath bridge fully onto the bath bridge. Mount the bath bridge on the rear of the bath with the two enclosed cross-head screws.
- Ensure that the ventilation opening at the back of the control head is free.
- Keep a distance of at least 20 cm free on all sides of the device.

Important: Set the flow distribution to INT so that during operation as a bath thermostat (without external consumer) the flow is discharged from the opening for the internal bath circulation.

When mounting the pump connection set, the outflow nozzle of the pump set must be closed (use sealing plug) or connected to the return nozzle by a hose.

- For bath temperatures above 70 °C attach the sticker included in the supplied items to an easily visible point on the bath.



- The control head must be removed when optionally fitting the pump connection set (⇒ 6.2). To do this, release the two cross-head screws and carefully take the control head out of the bath bridge.

Assembly as cooling thermostat

Notice

Falling / toppling equipment

Property damage

- Do not tilt the cooling device during transport and never turn it upside down.

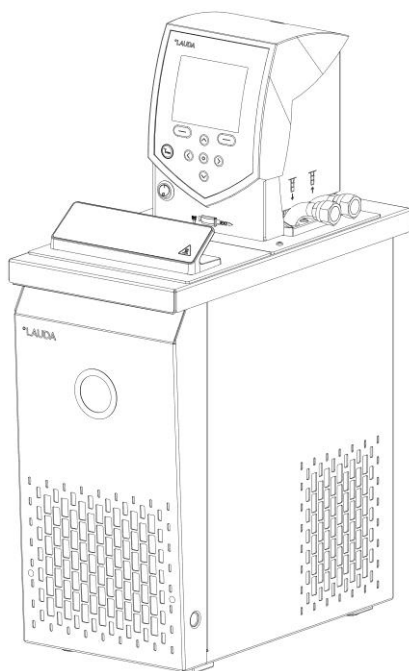

- After transport, site the device in place where possible two hours before putting it into operation so that, if necessary, oil deposits can form again and the compressor can develop its maximum power.
- Do not cover the ventilation openings.
- Keep a distance of at least 40 cm free on all sides of the device.
- Set the flow distribution to INT so that during operation as a bath thermostat (without external consumer) the flow is discharged from the opening for the internal bath circulation.
- Plug the appliance connector of the cooling underpart into the appropriate socket 51H and the control cable into the connection socket at the back of the operating panel.
- During operation as a bath thermostat without an external consumer and with the pump connection set fitted, the outflow nozzle of the pump connection set must be closed (use sealing plug) or connected to the return nozzle with a hose.
- For bath temperatures above 70 °C attach the sticker included in the supplied items to an easily visible point on the bath.



- Operation with external consumer (⇒ 6.2).

- For units operated with natural refrigerants, a sticker is located on the rear of the unit and for air-cooled units, above the condenser.



Device description of the calibration thermostat RE J 1225 G

The thermostats are especially equipped to calibrate glass thermometers or electric thermometers. The cylindrical (working) chamber can be adjusted in its height up to 20 mm approximately and therefore it is possible to adjust the surface of the liquid bath within the working chamber higher than the (bath) cover.

Therefore, the total immersing thermometers can be read right at the point of immersion. Additionally the separate working chamber provides a constant immersion depth, independent from the volume extension of the bath liquid, an extremely good temperature accuracy and distribution of temperature. There are pump connectors to connect other external closed circuits, but won't be available if the thermostat is used for calibrating.

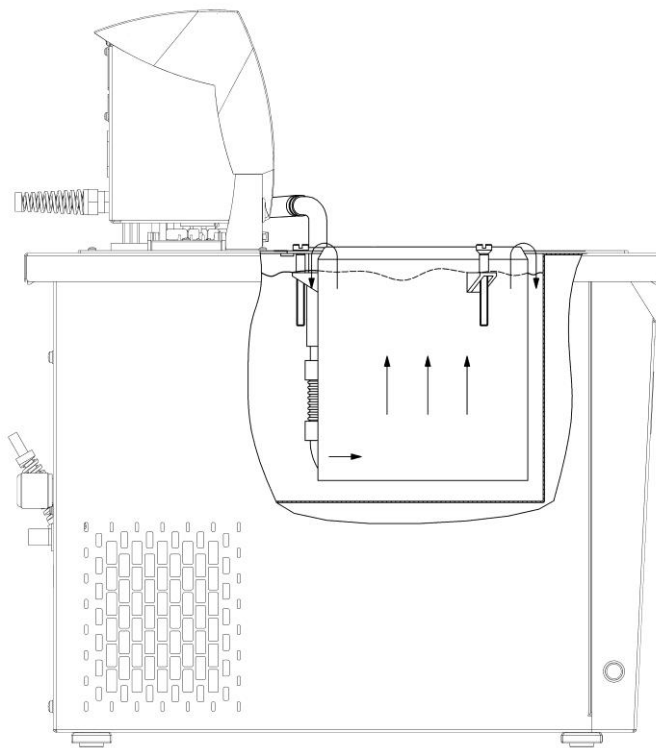

Side view

Connection tube LZM 045

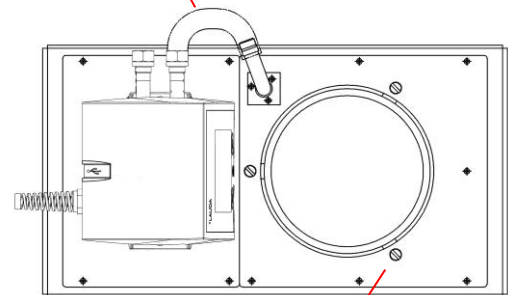

Screw for adjustment (3x)

Top view

Starting up of the calibration thermostat

Firstly, assemble the connecting tube LZM 045 as per diagram.

Attention! Do not bend the tube! Hold up with open-end wrench SW 14 mm.

Please move the connecting screws for adjustment of the cylindrical chamber always gradually (about 2 rotations). Adjust the working chamber as per diagram, and fix it that way it rises 3 mm above the bath opening. Refill the bath liquid only up to 15 mm underneath the bath opening and only at working temperature and switched-off pump.

Recommendation for the adjustment of the cylindrical working chamber

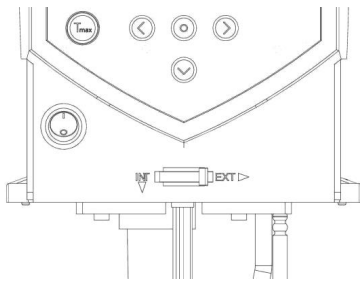

Maintenance of the calibration thermostat

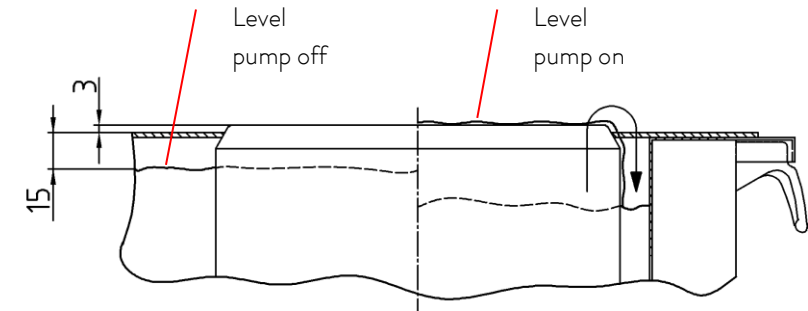

Switch the button for the distribution of the pump flow to “EXT”.

The position **EXT** gives the greatest flow in the external circuit (cylindrical chamber).

For cleaning purposes and check-up of the bath liquid, we recommend lifting the front cover with the chamber as follows: Remove the connecting flange and release the screws M4. This structural component can now be taken out.

Connection of the cooling water

Note that the following conditions apply for the connection of the cooling water supply:

Cooling water pressure (feed - outlet)	max. 10 bar overpressure
Differential pressure (feed - outlet)	min. 3.0 bar
Cooling water temperature	10 to 15 °C recommended, 10 to 30 °C admissible with power restrictions)
Cooling water quantity	see Technical Data (⇒10)
Cooling water hose for connection to the device	min. 13 mm

Ways of adjusting the pump flow

The circulation of the heat transfer liquid by the pump can be divided between internal (**INT**) and external (**EXT**) with the aid of the selector switch at the front on the control head (flow distribution). This adjustment is continuously variable and is also possible at any time during operation.

The adjustment between internal and external circulation is only practicable when an external consumer is connected. You need a pump connection set for this. This set is included as standard with cooling devices and with the heating devices E 4 G and ET 15 G. With immersion thermostats and the other heating thermostats the pump connection set is available as an accessory (⇒ 9).

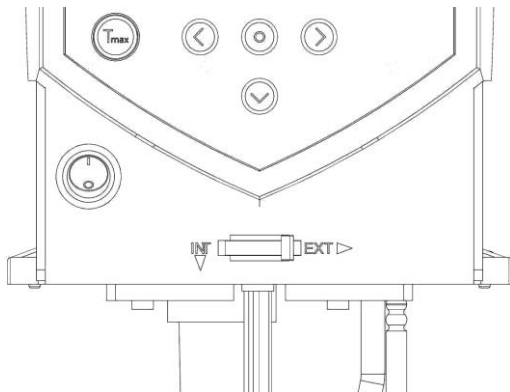

With a pure bath application the selector switch has to be set to **INT**.

6.2 Connection of external consumers

For heating thermostats a pump connection set is available as an accessory (⇒ 9) for the connection of an external consumer.

This pump connection set is included as standard with cooling thermostats and with the heating thermostats E 4G and ET 15 G.

Notice	Confusing pump connector and cooling coil
	<i>Environmental hazard from leaking heat transfer liquid</i>
	<ul style="list-style-type: none"> • Follow the illustrations in this section.

Notice	Leaks from consumers, hoses and accessories
	<i>Environmental hazard from leaking heat transfer liquid</i>
	<ul style="list-style-type: none"> • Always secure the hoses with suitable safety devices.

The ECO thermostat can be equipped as an immersion thermostat or as a circulation thermostat.

Immersion thermostat/heating thermostat

With heating thermostats the control head must first be removed by releasing the two cross-head screws from the bath bridge.

For optional operation with the pump first mount the pump connection set and then carry out the complete assembly:

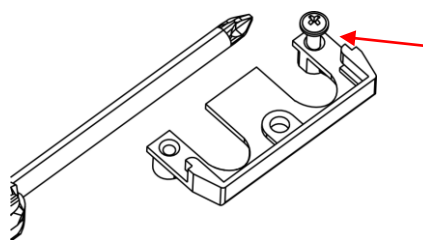

Cut the thread with the screw

- Cut the thread on the holed flange already before assembly.

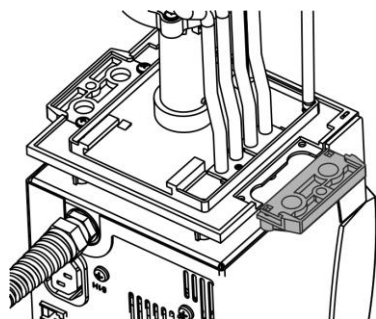

The pump connection set can be mounted on one side of the control head (see illustration).

- Withdraw the mains plug.
- Use a soft underlay to avoid scratches to the upper side of the control head.
- With heating thermostats: Remove the flat seal.
- Remove the blind flange by releasing the two cross-head screws.

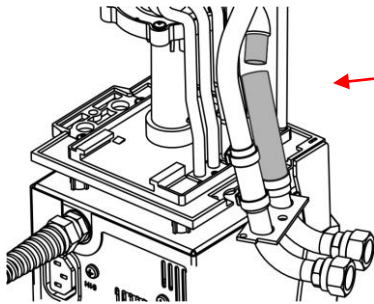

- Turn the pump output downwards for external bath circulation.
- Fit the hose section of the pump connection set onto the outflow elbow and place the pump connections in the position of the removed blind flange.

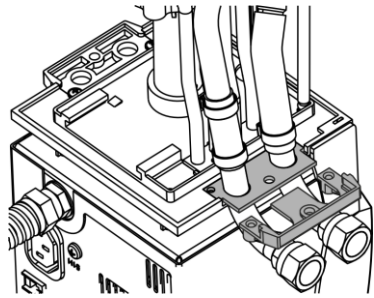

- Push the holed flange under the pump connections and fasten it with two cross-head screws to the underside of the control head.



Holed flange

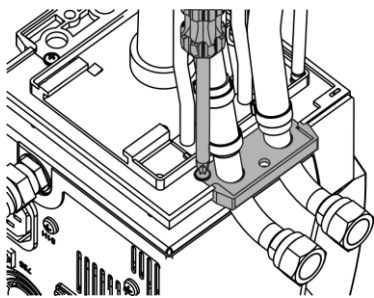

- Use the flat seal. Make sure the seal is in the correct position. On one side of the seal there are two steps:



They must be positioned on the side of the display.

- Refit the control head onto the bath bridge with the two cross-head screws.
- Select the division of the pump flow to suit the thermostating task using the selector switch on the front of the control head.

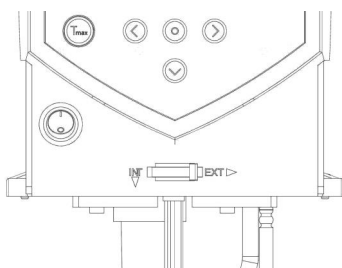

The position **EXT** gives the greatest flow in the external circuit.

With the position **INT** the external flow is throttled to a minimum and the outlet for the internal bath circulation is fully opened.

With positions between **INT** and **EXT** the flow is divided up between internal and external circulation.

Operation as circulation thermostat

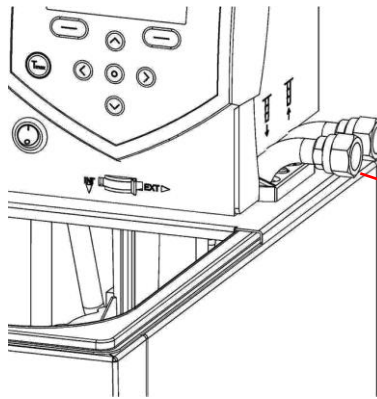

To ensure the greatest volume flow, with operation as a circulation thermostat ensure the shortest possible hose connections with the largest possible hose internal diameter.

- Connect a hose with 11 – 12 mm inside diameter (⇒ 6.4) to the pump connections.

Pump connection (⇒ labeling on the housing of the control head):

- Outflow **OUT** (front)
- Return to the bath **IN** (rear)

Note:

- Always use the largest possible cross-section and the shortest possible hose lengths in the external circuit.
- For a hose cross-section that is too small a temperature gradient occurs between the bath and external consumer due to a volume flow that is too low. In this case increase the bath temperature or the pump level appropriately.
- Secure the hoses with the aid of hose clips.
- If the thermostat is to be externally controlled, a temperature sensor must be fitted in the external consumer.
- If the consumers are situated at a higher level and with the pump stopped and air seeping into the external fluid circuit, then even with enclosed circuits the external volume may run empty. There is danger of the thermostat overflowing.
- If no external consumer is connected, the outflow nozzle must be sealed off or connected to the return nozzle by a hose.

Notice

Pump connections not closed off

Environmental hazard from leaking heat transfer liquid

- Fit sealing plugs to the pump connections when no external consumers are connected and set the flow distribution to internal "INT".

Notice

Thermostat overflow

Environmental hazard from leaking heat transfer liquid

- Do not position the thermostat above the consumer.

6.3 Filling and emptying

LAUDA accepts no liability for damage caused by the use of unsuitable heat transfer liquids (approved heat transfer liquids (⇒ 6.4)).



Contact with heat transfer liquid when filling / draining
<i>Harmful when inhaled, damage to eyes and skin</i>
<ul style="list-style-type: none"> • Pay attention to the safety data sheet for the heat transfer liquid. • Use CE gloves, protective clothing and eye protection during physical contact with heat transfer liquid. • Avoid splashing the heat transfer liquid. • Make sure that the drain tap is closed before filling.



Use of unsuitable heat transfer liquid
<i>Explosion, burns, scalds, fire</i>
<ul style="list-style-type: none"> • When selecting the heat transfer liquid, observe the admissible temperature range. • Only use LAUDA heat transfer liquids.

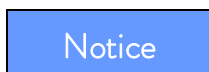

Overfilling containers, spilling heat transfer liquid
<i>Environmental hazard from leaking heat transfer liquid</i>
<ul style="list-style-type: none"> • Note the thermal volume expansion of the heat transfer liquid. • Where necessary, consider the displacement volume of the body being introduced. • Take the volume of external consumers into account.

Filling

- Withdraw the drain tap.
- Optimum operation is ensured with a filling level of 20 - 40 mm below the bath bridge (max. filling level: 20 mm).
- Operation is possible down to a filling level of 60 mm below the bath bridge; a low level alarm occurs from a filling level of approx. 90 mm below the bath bridge. (⇒ 8.1)
- When using oils as heat transfer liquids note that they expand on heating (approx. 10 % per 100 °C).
- Take into account the displacement volume of any objects to be introduced into the bath.
- With a connected external consumer the complete expansion takes place in the bath.

Draining and changing the heat transfer liquid

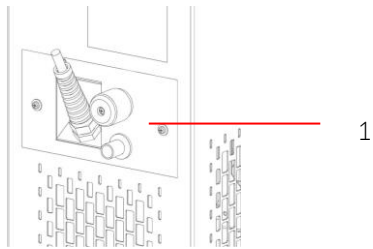

- Switch off the thermostat and withdraw the mains plug.
- Allow the device and heat transfer liquid to cool down to or warm up to room temperature.
- Push a hose onto the bath drain point.
- Drain the heat transfer liquid via the drain tap at the back of the device.

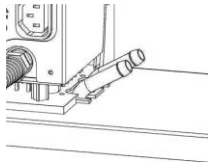

- 1 Drain tap, cooling thermostats
2 Drain tap, heating thermostats



Completely drain the bath, external consumers, accessories and hose connections and flush or clean them (e.g. with new heat transfer liquid).



Contact with hot / cold heat transfer liquid

Scalds, frostbite

- Bring heat transfer liquids to room temperature before draining.
- Make sure that the drain tap is closed after draining.



Delay in boiling and thermal decomposition due to liquid residues

Burns, scalds, development of harmful vapors

- Remove all old heat transfer liquid completely from the bath, external consumers, accessories and hoses. Flush and clean them with new heat transfer liquid.

6.4 Heat transfer liquids, cooling water and hoses

Note:

- Tap water is unsuitable for operation with the thermostat due to the calcium carbonate content. The bath vessel may calcify.
- High purity water (from ion exchangers) and distilled or bidistilled water are unsuitable for operation due to the corrosive properties of these media. High purity water and distillates are suitable as a medium after the addition of 0.1 g of soda (Na_2CO_3 , sodium carbonate) per liter of water.
- Water containing iron (rust formation), chlorine (pitting) and untreated river water ("algae formation") is unsuitable.
- The bath vessels of the LAUDA ECO thermostats are produced in stainless steel 1.4301 and are accordingly resistant to mechanical and chemical stresses.
- Metals have different electrochemical potentials. Therefore, in the case of direct contact between the tank and a frame (copper for example) electrochemical oxidation may occur. The bath corrodes despite the use of high quality materials on the tank. Avoid the use of this type of frame or direct contact with it or contact with non-ferrous metal samples and the inside of the container. Use original LAUDA stainless steel frames or commercially available frames in temperature-resistant plastics.

a) Approved heat transfer liquids

LAUDA designation	Operating temperature range	Chemical characterization	Viscosity (kin)	Viscosity (kin) at temperature	Flash point	Container size		
						Catalogue number		
	°C		mm ² /s at 20 °C	mm ² /s	°C	5 L	10 L	20 L
Kryo 51	-50 – 120	Silicone oil	5	34 at -50 °C	120	LZB 121	LZB 221	LZB 321
Kryo 30 ②	-30 – 90	Monoethylene glycol/water mixture	4	50 at -25 °C	--	LZB 109	LZB 209	LZB 309
Kryo 20	-20 – 170	Silicone oil	11	28 at -20 °C	170	LZB 116	LZB 216	LZB 316
Therm 160 ③	60 – 160	Polyalkylene glycol	141	5 à 140 °C	260	LZB 106	LZB 206	LZB 306
Therm 180	0 – 180	Silicone oil	23	36 at 0 °C	250	LZB 114	LZB 214	LZB 314
Therm 250	50 – 250	Silicone oil	125	45 at 50 °C	300	LZB 122	LZB 222	LZB 322
Aqua 90 ①	5 – 90	Decalcified water	1	--	--	LZB 120	LZB 220	LZB 320

① At higher temperatures vaporization losses occur. In this case use a bath cover (⇒ 9). Use distilled water or pure demineralized water only after adding 0.1 g of soda (Na_2CO_3 sodium carbonate) per liter of water. Otherwise there is the risk of corrosion!

② The proportion of water reduces with longer working at high temperatures and the mixture becomes flammable (flash point 119 °C). Check the mixing ratio using a hydrometer.

③ Not suitable for polycarbonate baths.

Silicone hoses are not suitable for silicone oils!

EPDM hoses are not suitable for mineral oils!

- When choosing the heat transfer liquid, it must be noted that at the lower limit of the operating temperature range impairment of the heat transfer properties is to be expected due to the increasing viscosity. Therefore, only use the full operating temperature range where necessary.
- The working ranges of the heat transfer liquids and hoses are general figures which can be tightened due to the operating temperature range of the devices.
- Never use contaminated heat transfer liquids. Contamination of the pump chamber may lead to the pump jamming and the device then switching off.
- Pay attention to the safety data sheet for the heat transfer liquid.
- Follow the regulations for disposal of the used heat transfer liquid.

If required, you can request the safety data sheets at any time. (⇒ 8.7)

b) Cooling water

Certain requirements are placed on the cooling water with regard to purity. Depending on the cooling water contamination, a suitable method of purification and/or treatment of the water must be employed. The condenser and the complete cooling water circuit can become blocked, damaged and leaky due to unsuitable cooling water. Extensive consequential damage may arise on the whole cooling circuit. The cooling water quality depends on local conditions. If a fault or damage occurs due to unsuitable water quality, it is not covered by our guarantee.

Important: Danger of corrosion of the cooling water circuit due to water of unsuitable quality.

- Free chlorine (e.g. from disinfectants) and water containing chlorine lead to pitting in the cooling water circuit.
- Distilled, deionized or demineralized water is unsuitable due to its corrosive properties and leads to corrosion in the cooling water circuit.
- Seawater is unsuitable due to its corrosive properties and leads to corrosion in the cooling water circuit.
- Water containing iron or iron particles leads to rust formation in the cooling water circuit.
- Due to the high lime content hard water is not suitable for cooling and leads to calcification in the cooling water circuit.
- Cooling water with suspended matter is not suitable.
- Untreated and unpurified river or cooling tower water is not suitable due to its microbiological content (bacteria), which can become deposited in the cooling water circuit.
- Putrid water is not suitable.

Suitable cooling water quality

Specification	Value and Unit
pH – value	7.5 – 9.0
Hydrocarbonates [HCO ₃ ⁻]	70 – 300 mg/L
Chlorides (Cl ⁻)	< 50 mg/L
Sulfates [SO ₄ ²⁻]	< 70 mg/L
Hydrocarbonates [HCO ₃ ⁻] / sulfates [SO ₄ ²⁻]	> 1.0
Total hardness	4.0 – 8.5 °dH
Conductivity	30 - 500 µS/cm
Sulfites [SO ₃ ²⁻]	< 1 mg/L
Free chlorine gas (Cl ₂)	< 0.5 mg/L
Nitrates (NO ₃ ⁻)	< 100 mg/L
Ammonia (NH ₃)	Not permissible
Iron (Fe), dissolved	< 0.2 mg/L
Manganese (Mn), dissolved	< 0.05 mg/L
Aluminum (Al), dissolved	< 0.2 mg/L
Free aggressive carbonic acid (CO ₂)	Not permissible
Hydrogen sulfide (H ₂ S)	Not permissible
Algae growth	Not permissible
Suspended matter	Not permissible

Water pollution due to leakage

To avoid pollution due to a leak in the cooling water system it is recommended that a leakage-water detector with a water cut-off is installed.

c) Approved elastomer hoses

Type of hose	Internal diameter Ø mm	Temperature range °C	Application range	Catalogue number
EPDM hose uninsulated	9	10 – 90	For all LAUDA heat transfer liquids except mineral oils	RKJ 111
EPDM hose uninsulated	12	10 – 90	For all LAUDA heat transfer liquids except mineral oils	RKJ 112
EPDM hose insulated	12 External Ø approx. 35 mm	-35 – 90	For all LAUDA heat transfer liquids except mineral oils	LZS 021
Silicone hose uninsulated	11	10 – 100	Water or Water/glycol mixture	RKJ 059
Silicone hose insulated	11 External Ø approx. 35 mm	-60 – 100	Water or Water/glycol mixture	LZS 007

Note:

- EPDM hoses are **not** suitable for mineral oils!
- Silicone hoses are **not** suitable for silicone oils!
- Secure the hoses with the aid of hose clips.

d) Approved metal hoses in non-rusting stainless steel with union nut M16 x 1, inside diameter 10 mm

Type	Length (cm)	Temperature range °C	Application range	Catalogue number
MC 50	50	10 – 400	With simple insulation For all LAUDA heat transfer liquids	LZM 040
MC 100	100	10 – 400		LZM 041
MC 150	150	10 – 400		LZM 042
MC 200	200	10 – 400		LZM 043
Pump short circuit	18	10 – 400		LZM 044
MK 50	50	-90 – 150	With foam insulation for the cooling range For all LAUDA heat transfer liquids	LZM 052
MK 100	100	-90 – 150		LZM 053
MK 150	150	-90 – 150		LZM 054
MK 200	200	-90 – 150		LZM 055
Pump short circuit	18	-90 – 150		LZM 045

6.5 Cooling of heating thermostats

At bath temperatures slightly above the room temperature (approx. 2 – 5 K) operation is possible at a low pump level (1 or 2) without cooling. For temperatures below room temperature cooling must be used.

With the immersion thermostat use a cooling coil (⇒ 6.1).

With bath and circulation thermostats the cooling coil is already built in as standard.

Connect external cooling fluid to the cooling coil. At temperatures above 20 °C, fresh water can be used. Ensure the lowest possible water consumption.

6.6 First switch-on

Make sure that the details on the name-plate match mains voltage and frequency.

Notice	Use of inadmissible mains voltage or frequency
	<i>Property damage</i>
	<ul style="list-style-type: none">• Compare the rating label with the available mains voltage and frequency.

Note for electric installation on site:



The devices must be protected with a 16 ampere circuit breaker fitted during installation.

Exception: Devices with 13 ampere UK plugs.

Note:

- The device mains plug is used as a mains disconnection component. The mains plug must be easily recognizable and easily accessible.
- Only connect units to sockets having a safety earth conductor (PE). No liability is accepted for incorrect mains connection.
- Make sure that if not using an external consumer, the pressure nozzle is closed off or short-circuited to the return nozzle.
- Make sure that the unit is filled according to section (⇒ 6.3).

Menu language

When switching the device on for the first time, you can select your desired menu language with the cursor keys  and . Confirm your choice with the enter key .



The menu language can be changed at any time (⇒ 7.4.7).

6.7 Installation of modules

When installing modules always follow this safety information:



Live parts during module installation
<i>Electric shock hazard</i>
<ul style="list-style-type: none"> • Disconnect the device from the mains before module installation. • Have the installation carried out only by specialists.

The ECO heating and cooling thermostats can be supplemented with interface modules which are inserted at the rear of the control head in two different module slots.

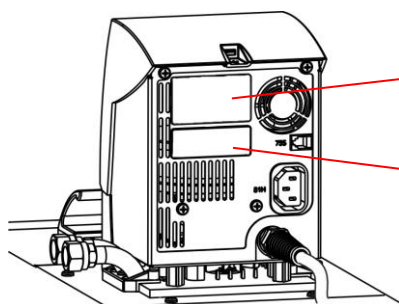

Upper module receptacle (approx. 51 mm x 27 mm) for RS 232/484 module / analog module / contact module / Profibus module

Lower module receptacle (approx. 51 mm x 17 mm) for Pt100/LiBus module

- Touch the bare earthed stainless steel back panel of the ECO thermostat to discharge any electrostatic charge.
- Remove the module from the packaging.
- Switch off the thermostat and withdraw the mains plug.

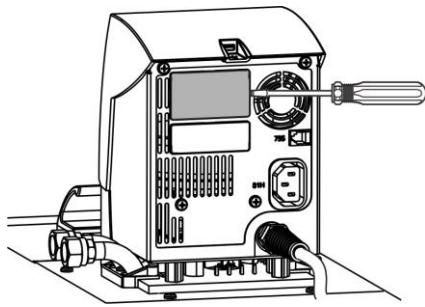

- The plastic cover has a recess on each side to ease removal. Insert a screwdriver first in the right and then in the left recess of the plastic cover and carefully lever it up.

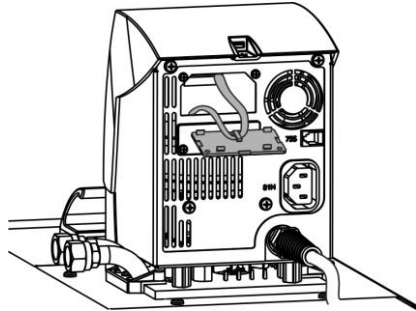

- Pull the bus connecting lead out of the plastic cover.

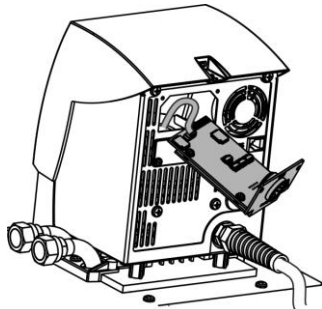

- Plug in the bus connecting lead (red plug in the red socket).
- Introduce the module into the appropriate receptacle and fasten it using the two cross-head screws.
- Insert the mains plug again and switch on the thermostat.

The connectors have reverse-polarity protection. The plug has a projection which slides into a notch on the socket.

7 Operation

Always follow this safety information:



Control head drops into bath
<i>Electric shock hazard</i>
<ul style="list-style-type: none"> • Make sure that the control head mounting is securely joined to the bath.



Addition of liquids with low boiling points (e.g. water to hot oil), alteration of liquid properties (reducing the flash point)
<i>Explosion, burns, scalds, fire</i>
<ul style="list-style-type: none"> • Site the device in suitable premises. • Avoid dripping water and condensation. • Do not position any small parts and liquids above the device. • Keep the cover on the thermostat (if present) closed. • Prevent the ingress of secondary liquids (e.g. from customer's heat exchanger). • Do not work with liquids in the direct vicinity of the device. • Check the heat transfer liquid at least every six months (e.g. mixing ratio with a hydrometer).



Skin contact with heat transfer liquid or hot / cold surfaces
<i>Burns, scalds, frost bite, impacts, cuts, snagging</i>
<ul style="list-style-type: none"> • Only operate the device with its housing. • Avoid splashes and hand contact with hot or cold heat transfer liquid. • Use CE gloves, protective clothing and eye protection. • Affix the symbol "Hot surface". • Do not touch the connecting and drainage points in the operating state.



Contact with vapors from the heat transfer liquid
<i>Harmful by inhalation</i>
<ul style="list-style-type: none"> • Use an extractor hood. • If possible, use a bath cover.



<p>Bath overflow due to thermal expansion or immersion of objects</p>
<p><i>Burns, scalds, frostbite</i></p>
<ul style="list-style-type: none"> • Take the volume of external consumers into account. • Take into account the increase in volume with a rise in temperature.



<p>Hot vapor formation / discharge of boiling cooling-water on the cooling coil</p>
<p><i>Burns, scalds</i></p>
<ul style="list-style-type: none"> • Filling of cooling coil with cooling water only admissible up to T_{max} of 100 °C!

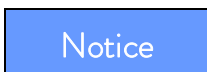

<p>Inadmissible operating temperatures; temperature difference between outflow and product too large</p>
<p><i>Property damage (consumers, external components)</i></p>
<ul style="list-style-type: none"> • Note that an externally controlled bath temperature, especially during a transient response, may differ substantially from the set-point temperature. • Note the various limitation options (T_{ih}, T_{il}, T_{max}, correction limitation). • Set the overtemperature switch-off point T_{max} according to the heat transfer liquid. T_{max} must be below the flash point.

Also note the following for cooling devices with natural refrigerant:



Danger of overpressure due to a too high ambient temperature at standstill
<i>Explosion</i>
<ul style="list-style-type: none"> Note the admissible storage and operating temperatures.



Leaky refrigerant circuit
<i>Explosion, fire, harmful by inhalation</i>
<ul style="list-style-type: none"> Do not operate any switch on the device nor at any other point in the room. Do not produce any flames nor sparks. Immediately ventilate the room and contact LAUDA Service. Take into account the required size of the siting room (minimum room volume 1 m³ per 8 g of propane R-290).



Danger of overpressure due to a too high ambient temperature at standstill
<i>Emission of refrigerant and injury due to explosion</i>
<ul style="list-style-type: none"> Note the admissible storage and operating temperatures.

7.1 Switching on



- Switch on the device with the mains switch. An acoustic signal sounds.

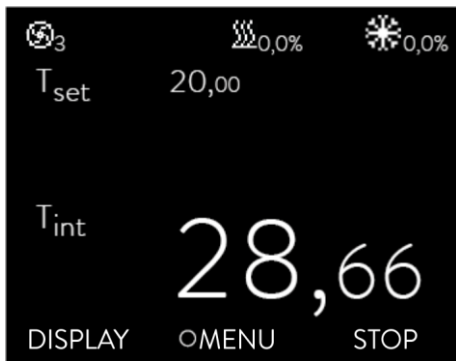

The current bath temperature (T_{int}) is displayed with the status display above it, the expanded status display at the top margin and the soft-key bar at the bottom margin.

The pump starts (exception: "Standby" operating status).

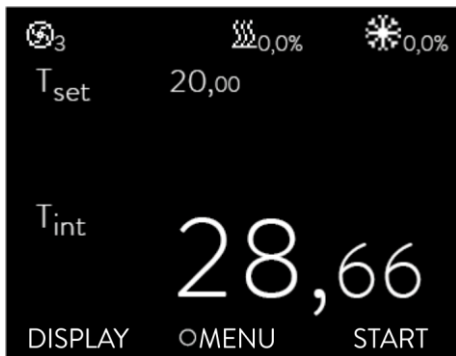

When standby is activated (\Rightarrow 7.4.4), the last operating values are taken over.



With the key T_{max} you check or change the overtemperature switch-off point:

- On pressing the key T_{max}  the value in the upper line is displayed.

(Setting the overtemperature switch-off point T_{max} (\Rightarrow 7.4.1)).

7.2 Menu structure

With the soft keys you can select the following menu points with the GOLD control head:

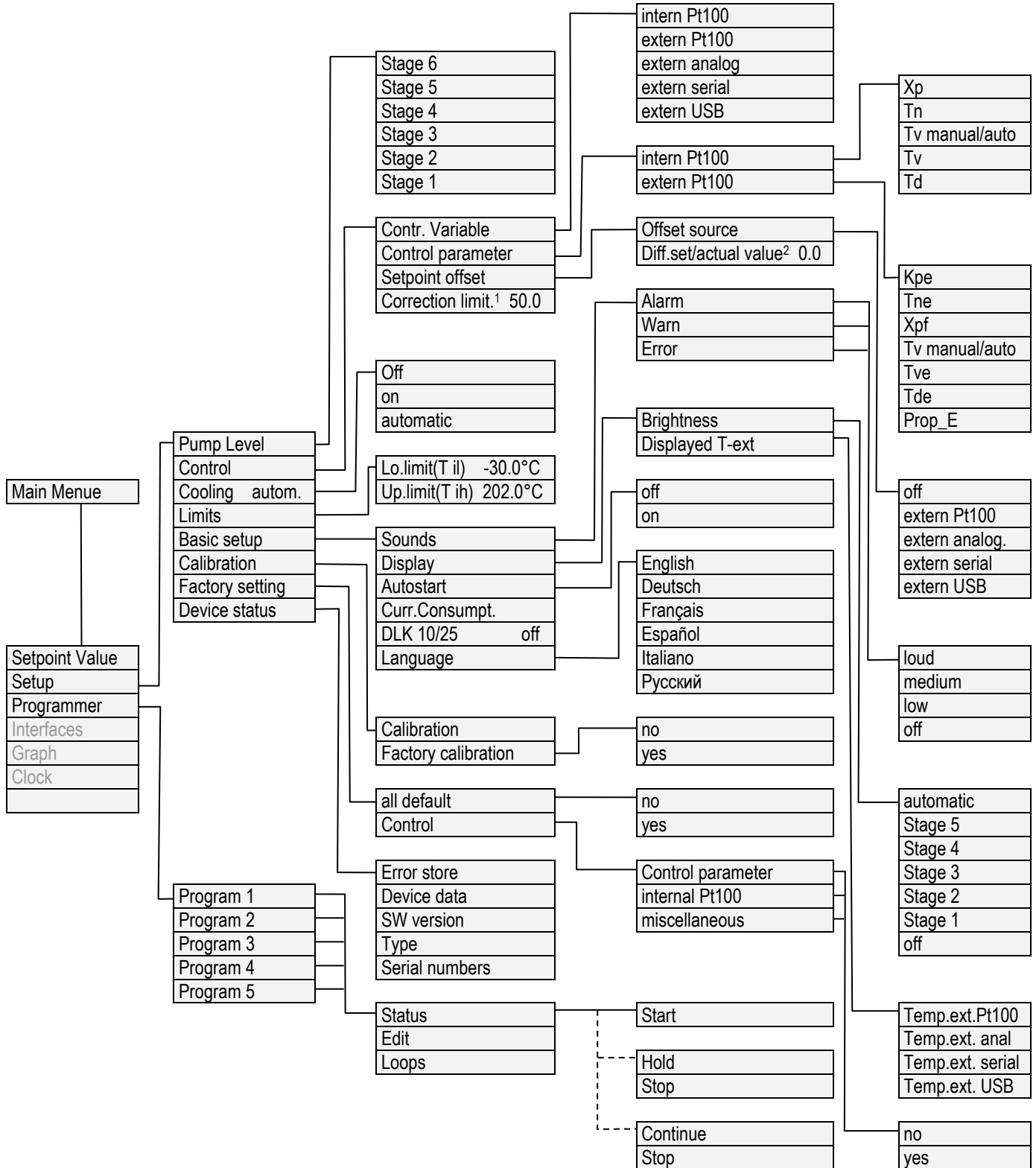

¹ Correction limitation

² Difference between set point/actual value

Continued...

Continued from previous page

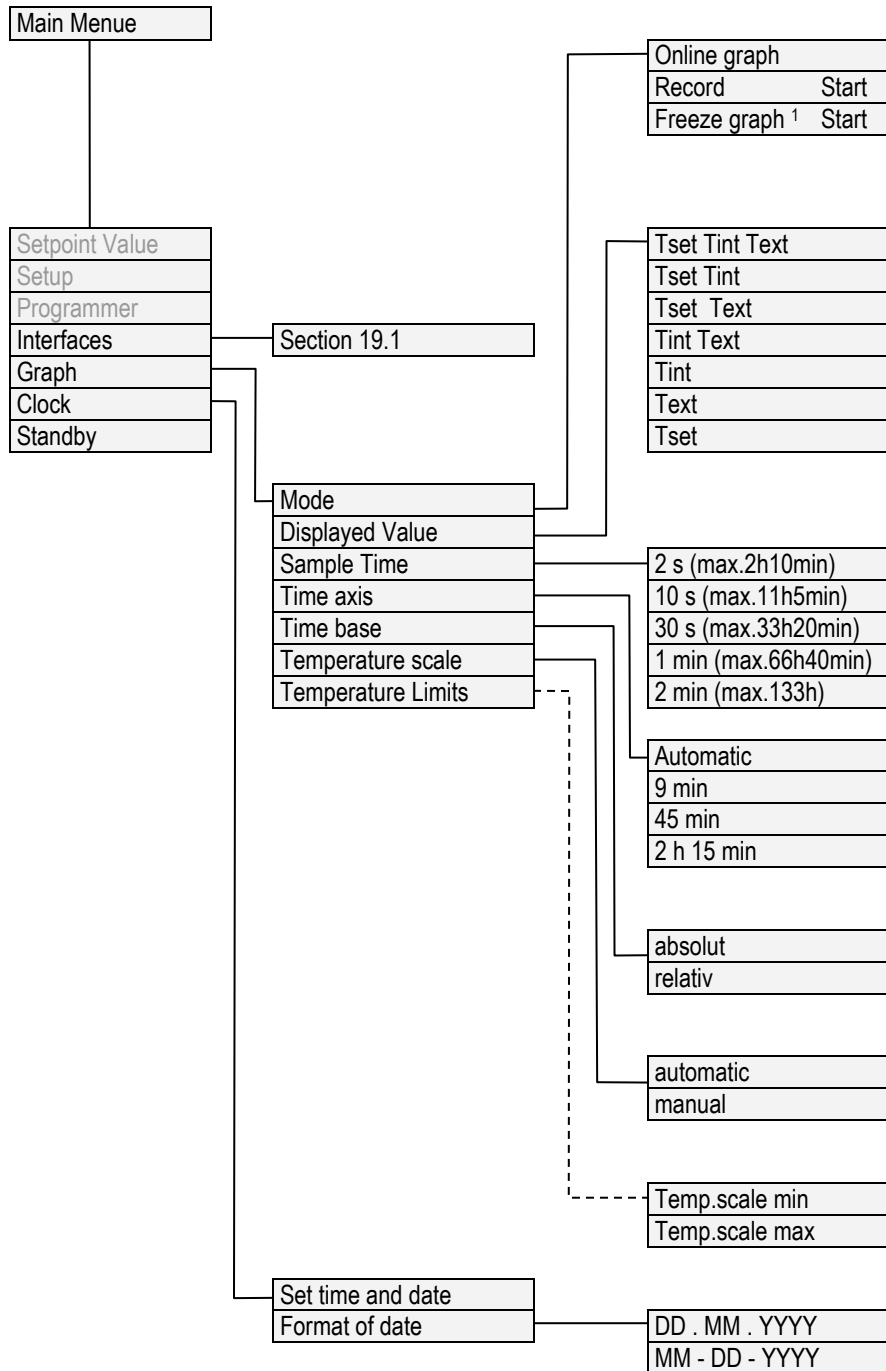

¹ Freeze Graph

7.3 Display representation

The ECO thermostats offer you intuitive menu guidance. In the following the possible window views and the symbols used are explained.

7.3.1 Basic window



The following information is displayed depending on the operating status:

- 3 Pump runs with the displayed pump level, graphical display with bars.
- 25 % Heating is active and heats with displayed percentage of total power.
- 75 % Heating is active and cools with displayed percentage of total power (only with cooling devices).
- T_{ext} Temperature of the external application (if external temperature sensor is connected)
- T_{set} Set-point temperature
- T_{int} Current bath temperature
- DISPLAY, MENU, STOP Soft-key bar; function call via associated keys

If standby is activated (\Rightarrow 7.4.4), "Standby" appears instead of the symbol for heating/cooling.

7.3.2 Menu window

The menu of the ECO GOLD thermostats consists of several menu levels. With the cursor keys , , , you can call the individual menu points and select them with the enter key .

	Symbolizes the enter key or its assigned function.
	Displays the currently selected function.
	Indicates that further menu levels (submenus) are present.
	The padlock symbolizes a blocked function. (Possible reasons: No access rights or function deactivated by parameter settings).



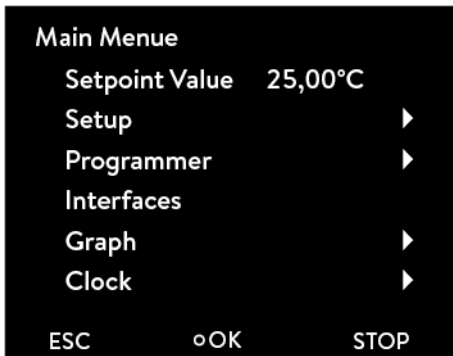

Examples of display representation:

Main menu



In the main menu selected menu points are displayed inversely.

The soft-key bar is shown in the lower region of the display. The following functions, for example, can be selected with the soft keys:

- ESC  You are returned to the main menu.
- OK  You are taken to the submenu (this can also occur by pressing ).
- STOP  Standby is activated.

Submenu "Cooling"

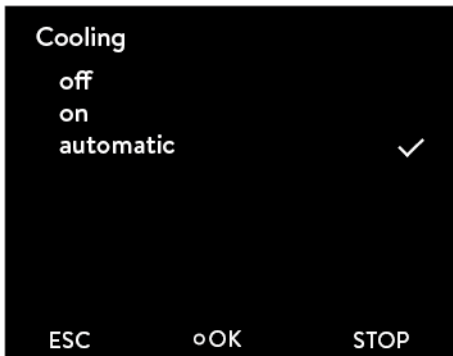

The following information is displayed in this window example:

- The setting **on** is displayed inversely and can be selected by pressing the enter key .

A tick ✓ behind the menu point indicates that this setting is active. In the example the cooling is set to "automatic".

7.3.3 Entry window

Values are input using the entry window.

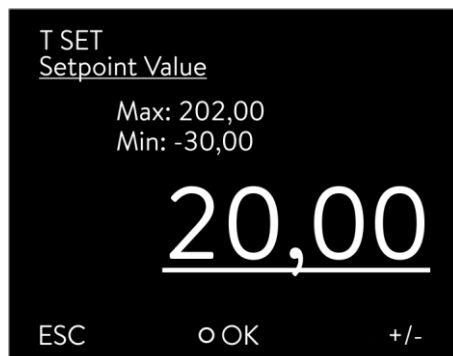



In the entry window the following information is displayed:





The first line contains the input parameter in short form (cf. example: T_{set}).

The parameter is located below this in plain text.

Max. and Min. state the limits for the value to be entered.

The value to be entered is shown in large characters. The cursor flashes under the value.

You can change the value with the cursor key  or . If you keep one of the two cursor keys pressed longer, input is speeded up.

By pressing  or  you can also select numbers individually and change them with  or .

By pressing  (+/-) the arithmetic sign can be changed.

The enter key  takes over the set value.

By pressing  (ESC) you are returned to the menu level without any change.

7.3.4 Graphics window

The ECO GOLD thermostats offer you the possibility of displaying temperature traces graphically.

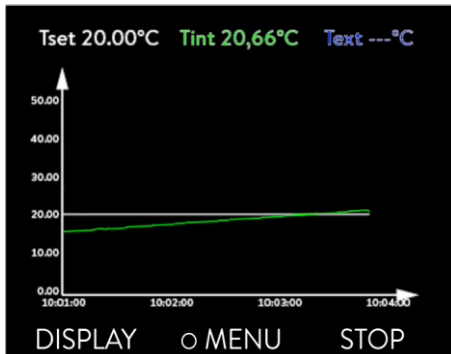

In the graphics window the following information is displayed depending on the setting:

- T_{set} set-point temperature (grey)
- T_{int} internal bath temperature (green)
- T_{ext} Temperature on the external consumer, external temperature sensor (blue).

7.4 Basic setup

In this section the settings required for using the device as prescribed are summarized. For more extensive settings refer to the appendix.

7.4.1 Setting the overtemperature switch-off point T_{max}



Overheating due to entering an incorrect T_{max} and set-point temperature

Burns, scalds, fire



- Set T_{max} in each case according to the heat transfer liquid used T_{max} must be below the flash point.

- Hold the key  pressed during the complete setting procedure:





- Press the enter key .

The entry window appears. The cursor flashes under the T_{max} value. The maximum and minimum adjustable temperature values are displayed.

- Change the value with  or .

Note: With a longer depression the figures increment faster.



- Single figures can be selected by pressing  or .
- Confirm your choice with the enter key .

On releasing  you are returned to the menu level without any change.

For T_{max} the following applies: 5 Kelvin above the required maximum bath temperature, but below the flash point of the heat transfer liquid.

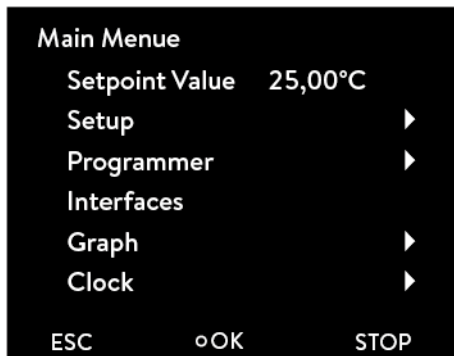



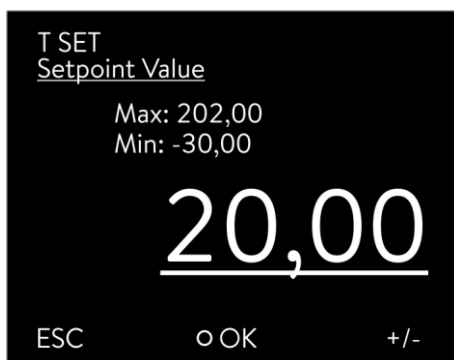

7.4.2 Setting the temperature set-point value



- Access to the main menu level is obtained by pressing the enter key .
- Select the menu point "Set-point temperature" using the enter key .



The entry window appears. The cursor below the temperature value flashes and can be changed within the displayed limits.



- Change the value with  or .
- Single figures can be selected by pressing  or .
- By pressing  (+/-), with appropriate equipment, the arithmetic sign can be changed.
- Confirm your choice with the enter key .

- By pressing  (ESC) you are returned to the menu level without any change.

7.4.3 Setting the pump level

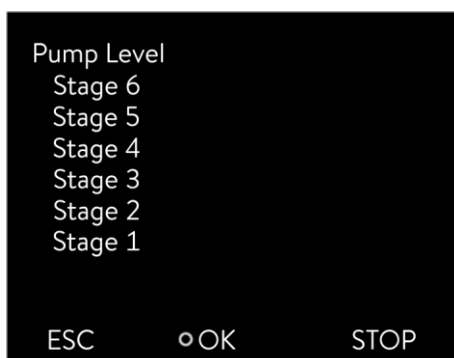
With the ECO Vario pump you have six pump levels available with which you can optimize the bath circulation, flow rate and pressure, the noise generated and the mechanical heat input. With small thermostats (e.g. E 4 G, RE 415 G, RE 420 G) without an external consumer power levels 1 to 3 are practicable and sufficient.



- Access to the main menu level is obtained by pressing the enter key .
- The adjacent menu window appears by selecting and confirming → Setup → Pump level.
- The level can be selected with  or . The selected level is immediately active without confirmation.

- You quit the menu by pressing  (ESC)  or .

7.4.4 Activating the "Standby" operating state

In the "Standby" mode the pump, heater and chiller are switched off. The operating display remains active.

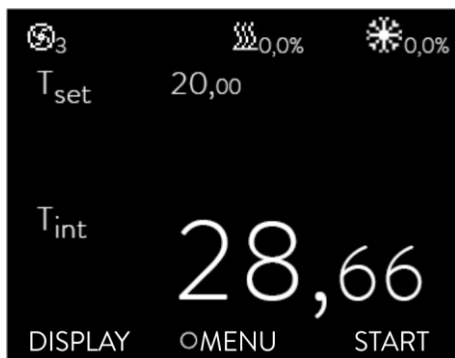

- Activate Standby by pressing (right soft key).

7.4.5 Defining temperature limits

With this function the temperature limits T_{il} and T_{ih} are defined. If, for example, you are using water as the heat transfer liquid, +5 °C is practicable as the minimum temperature and +95 °C as the maximum temperature.

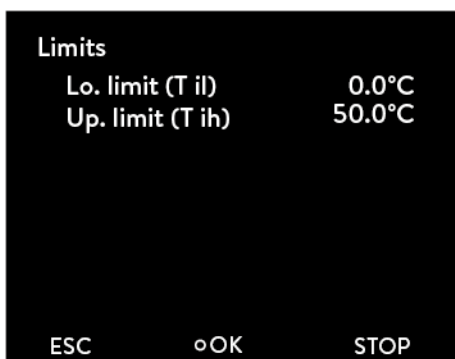

- Access to the main menu level is obtained by pressing the enter key .
- Selection and confirmation of → .

The adjacent menu window appears.

- Select the lower (T_{il}) or upper (T_{ih}) limit with or and confirm it with .

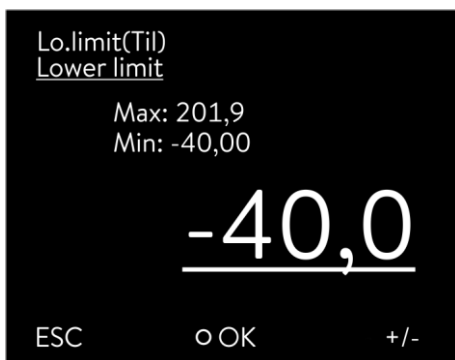

In the entry window the cursor flashes below the value to be changed.



The permissible adjustment range is indicated with Min and Max.

- Change the value with or .
- Single figures can be selected by pressing or .
- By pressing (+/-) the arithmetic sign can be changed.
- Confirm your choice with the enter key .

- By pressing (ESC) you are returned to the menu level without any change.

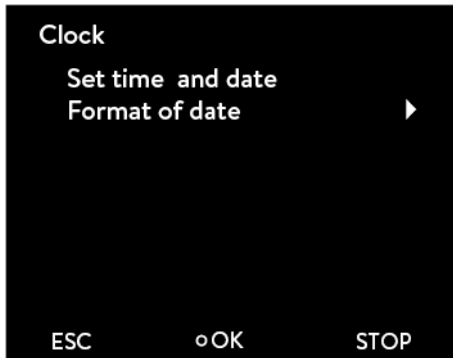

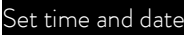

7.4.6 Setting the date and time

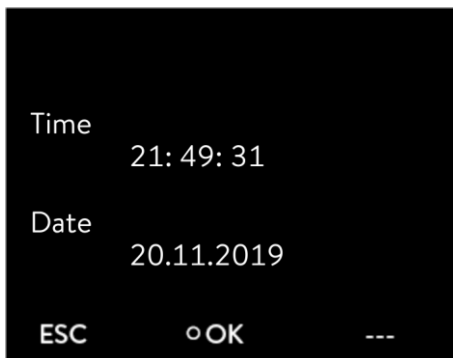







- Access to the main menu level is obtained by pressing the enter key .
- Selection and confirmation of   .

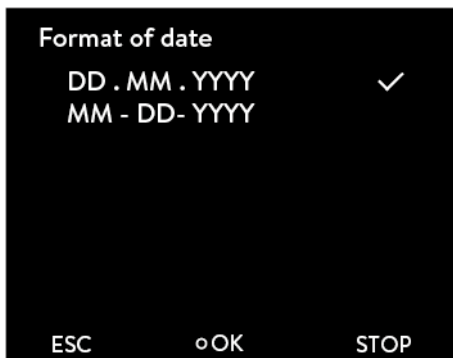

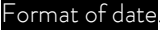
The adjacent menu window appears.

- The cursor flashes under the hours display.
- Change the value with  or .
- Single figures can be selected by pressing  or .







- The adjacent menu window appears on selecting the menu point .
- The selection with  or  and confirmation with  selects between the date formats  and .

- By pressing  (ESC) you are returned to the menu level without any change.

7.4.7 Selecting the menu language

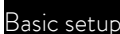

The ECO GOLD thermostats offer you the possibility of selecting the menu languages of English, German, French, Spanish, Italian and Russian.

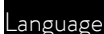

- Access to the main menu level is obtained by pressing the enter key .
- Selection and confirmation of     .

The adjacent menu window appears.

- Select the language with  or  and confirm with .

- By pressing  or  (ESC) you are returned to the menu level without any change.

8 Maintenance

8.1 Alarms, warnings and errors

Alarms: Alarms are relevant to safety. Pump, heating and chiller switch off.

Warnings: Warnings are normally not relevant to safety. The device continues to run.

Errors: If a malfunction occurs, switch off the unit at the mains switch. If the malfunction recurs after switching on the device, contact LAUDA Service Constant Temperature Equipment (⇒ 8.7) or your local service organization.

All alarms, warnings or error messages triggered on the ECO thermostat are shown in the display as text. The list with alarms and warnings can be found in the appendix.

Once the cause has been rectified, you can clear alarms and warnings with .

Warnings can be ignored with  without the message periodically appearing again.

8.1.1 Overtemperature protection: Alarm and checking



Overheating due to entering an incorrect T_{max} and set-point temperature

Burns, scalds, fire

- Set T_{max} in each case according to the heat transfer liquid used. T_{max} must be below the flash point.

Note: The devices are rated for operation with flammable and non-flammable liquids according to DIN EN 61010-1 and DIN EN 61010-2-010.

Set the overtemperature switch-off point as described in (⇒ 7.4.1). Recommended setting: 5 K above the desired maximum bath temperature (Remark: The overtemperature switch-off point T_{max} is controlled by a system which operates independently of the bath control).

Set the overtemperature switch-off point T_{max} below the flash point of the heat transfer liquid.



- The set overtemperature switch-off point is shown on pressing T_{max}  in the display.

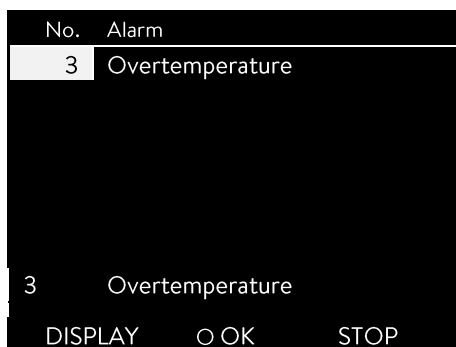

When the bath temperature is located above the overtemperature switch-off point, a two-tone alarm sounds. "Overtemperature" appears in the display, the heater switches off on all poles and the pump and chiller are switched off via the electronics.

- Rectify the cause of the malfunction.
- Wait until the bath temperature has cooled below the overtemperature switch-off point or set the overtemperature switch-off point higher than the bath temperature.

If "Overtemperature" appears in the display:

- Unlock the "Overtemperature" display with .

Before a longer unsupervised operation check the overtemperature **protection**:

- Slowly reduce T_{max} as described in (\Rightarrow 7.4.5). The thermostat should switch off when the actual temperature is greater than T_{max} .

Alarm signaling (see above) must occur.

- Reset the switch-off point to be higher than the bath temperature.
- Unlock the "Overtemperature" display with .

8.1.2 Low level: Alarm and checking

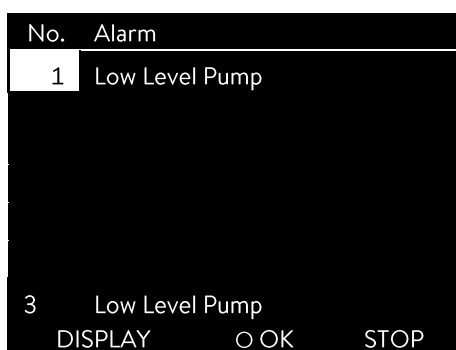

When the liquid level falls so far that the heaters are no longer completely covered with liquid, a two-tone alarm sounds. "Low Level Pump" appears in the display, the heater switches off on all poles and the pump and chiller are switched off via the electronics.

- Rectify the cause of the malfunction.
- Top up the missing heat transfer liquid (\Rightarrow 6.3 and 6.4).
- Unlock the "Low Level Pump" display with .

Check the safety system at regular intervals (\Rightarrow 8.3.2) by lowering the bath level. Do not carry out this test at a bath temperature below 0 °C or above 50 °C in order to avoid dangers due to temperatures that are too hot or too cold.

Alarm signaling (see above) must occur.

- Top up with heat transfer liquid.
- Unlock the "Low Level Pump" display with .

Switch the device off immediately and withdraw the mains plug if irregularities occur when checking the safety devices. Contact LAUDA Service Constant Temperature Equipment (\Rightarrow 8.7) or your local service.

8.2 Device status

Here, accumulated error messages as well as device and software data can be recalled.

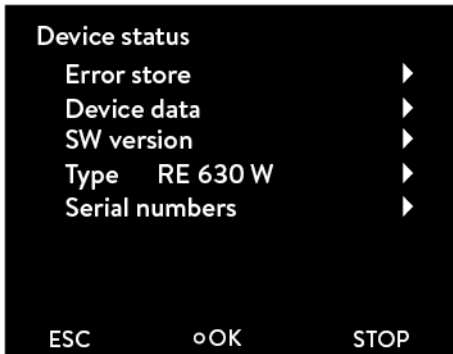

- Access to the main menu level is obtained by pressing the enter key .
- Selection and confirmation of → Setup → Device Status.

The adjacent menu window appears.

Here, you can now

- Errorstore Read out the error store
- Device data Request device data
- SW version Request the software version
- Type Request the device type
- Serial numbers Request serial number.

8.2.1 Store for errors, alarms and warnings

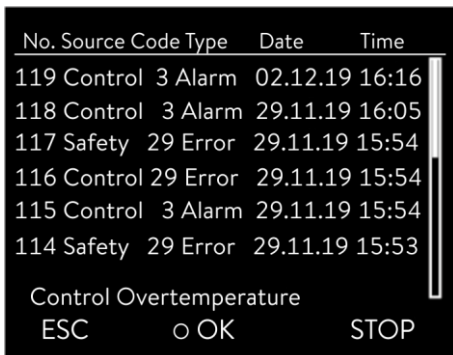

For error analysis the ECO thermostats have an error store in which up to 140 warning, alarm and error messages can be saved.



Error store

- confirm with .

The latest message is located in the first position.

- You navigate with  or  through the results which are sorted by date. The message text appears in the footer.

The relevant module which is causing the message is displayed under "Source".

"Code" is the coded alarm, warning or error description.

"Type" specifies alarm, warning or error. The list of alarms and warnings can be found in the appendix (⇒ 14).

8.2.2 Device data

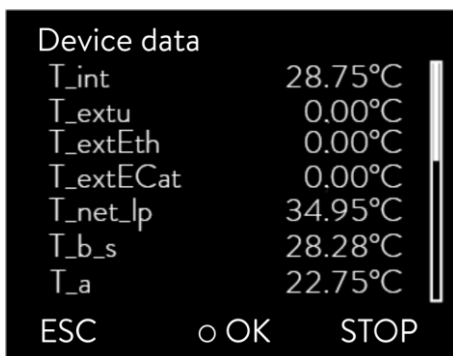

Device data

- confirm with .

The device parameters are displayed under the menu point Device data.

8.2.3 Software version

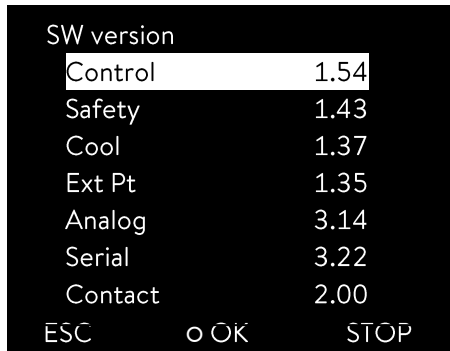

SW version

- confirm with .

Under the menu point SW version the appropriate software versions are displayed, depending on the device type and connected modules.

8.2.4 Displaying and changing the device type

Type

- confirm with .

The device type without the suffix "G" (GOLD) is shown in the menu.

You can change the device type .

Note:

With a change of device type parameters are re-initialized and control parameters adapted by the user are lost!

Therefore, the type change has a three second delay on the key depression.

The overtemperature switch-off point T_{max} is automatically adapted to the device type, i.e. with the ECO GOLD thermostat with a stainless steel bath $T_{max} = 202\text{ °C}$, for the ECO GOLD thermostat with transparent bath $T_{max} = 102\text{ °C}$.

You must now manually re-enter T_{max} (\Rightarrow 7.4.1), because otherwise the device enters the error status (error message in ECO GOLD "T max diff. Ctrl-Safety").

8.2.5 Displaying serial numbers

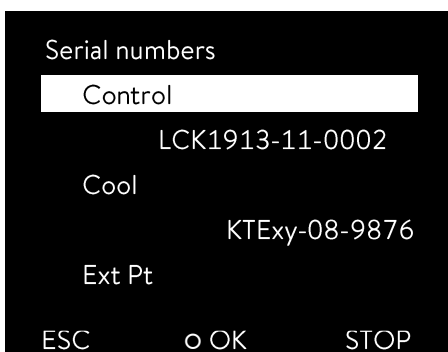

Serial numbers

- confirm with .

Under the Serial numbers menu point the serial numbers of Control and Safety are displayed. Provided they are available, the serial numbers of connected modules are also displayed.

8.3 Servicing

Follow all the safety information for cleaning and servicing the device.



Critical temperature of device parts, heat transfer liquid or accessories (hoses)
<i>Burns, scalds, frostbite</i>
<ul style="list-style-type: none"> • Bring the device parts, accessories and heat transfer liquid to room temperature before touching them. • Have repairs carried out only by a specialist. • Affix the symbol "Hot surface".

Also note the following for cooling devices with natural refrigerant:



Mechanical damage to the refrigerant circuit
<i>Explosion, fire</i>
<ul style="list-style-type: none"> • Do not operate any switch on the device nor at any other point in the room. • Do not produce any flames nor sparks. • Only service by specialist personnel admissible. • Immediately ventilate the room and contact LAUDA Service.

8.3.1 Cleaning



Live parts in contact with cleaning agents
<i>Electric shock hazard</i>
<ul style="list-style-type: none"> • Disconnect the device from the mains before cleaning.

Cleaning can be carried out with water with a few drops of a surfactant (washing-up liquid) added and with the aid of a damp cloth.

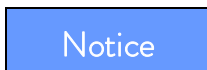

Live parts in contact with cleaning agents
<i>Property damage</i>
<ul style="list-style-type: none"> • Disconnect the device from the mains before cleaning. • Water and other liquids must not enter the control head.

Only clean the control head with the cleaning agents, water (with washing-up liquid), petroleum benzine or ethanol. Do not use any acetone or aromatic hydrocarbons (dilution) This would lead to permanent damage to the plastic surfaces.

Before all maintenance or cleaning work you must ensure that decontamination of the device is carried out if it has been in contact with hazardous materials.

8.3.2 Servicing intervals

Device part	Mandatory for initial operation and before any longer unsupervised operation, then with recommended frequency	Section	Remarks
Complete device			
External condition of device	Monthly		
Heat transfer liquid			
Inspect the heat transfer liquid	Every six months	(⇒ 8.3.3)	
Bath vessel with drain tap			
Sealing	Daily		External inspection
External hoses			
Material fatigue	Monthly		External inspection
Chiller			
Clean the air-cooled condenser	Monthly	(⇒ 8.3.4)	Cooling thermostat
Electronics			
Overtemperature protection	Quarterly	(⇒ 8.1.1)	
Low-level protection	Quarterly	(⇒ 8.1.2)	

Bring the device parts and accessories to room temperature before touching them.

8.3.3 Inspecting the heat transfer liquid

Contaminated or degenerated heat transfer liquid must be renewed.

The heat transfer liquid is to be checked for its usability as required, but at least every six months. Further use of the heat transfer liquid is only permissible if the inspection indicates this.

The test of the heat transfer liquid takes place according to DIN 51529; ("Testing and assessment of used heat carrier media"). Source: VDI 3033; DIN 51529.



Critical temperature of the heat transfer liquid
<i>Scalds, frostbite</i>
<ul style="list-style-type: none"> Bring the heat transfer liquid to room temperature for the analysis.

8.3.4 Cleaning the condenser

Air-cooled condenser

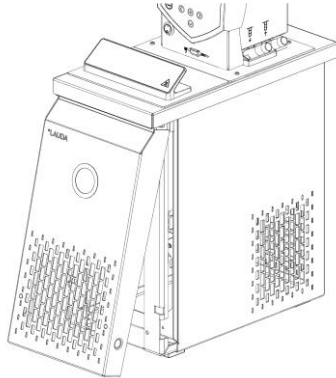

The cooling circuit is largely maintenance-free. Remove dust and contamination from the condenser at regular intervals (depending on operating period and exposure conditions).

- To do this, remove the front grille by grasping it at the bottom with both hands and pulling the grille to the front. To avoid damage, remove the front grille slowly and carefully.
- Then brush down the condenser and, where necessary, blow it out with compressed air.

Note:



Contact with sharp-edged vanes on the condenser during cleaning

Cuts

- Clean the condenser with suitable tools (e.g. hand brushes, compressed air...).

Also note the following for cooling devices with natural refrigerant:



Mechanical damage to the refrigerant circuit

Explosion, fire

- Do not operate any switch on the device nor at any other point in the room.
- Do not produce any flames nor sparks.
- Do not use any pointed objects when cleaning the condenser vanes.
- Immediately ventilate the room and contact LAUDA Service.

8.4 Fault finding

Before you contact the LAUDA Service (⇒ 8.7), check whether you can rectify the problem yourself with the following instructions.

In doing so, follow all this safety information:



Live parts when fault finding
<i>Electric shock hazard</i>
<ul style="list-style-type: none"> • Disconnect the device from the mains before the repair (e.g. when changing components). • Have repairs carried out only by a specialist.



Rotating / live parts when removing the ventilator fan
<i>Cuts, crushing, electric shock hazard</i>
<ul style="list-style-type: none"> • Disconnect the device from the mains before the repair. • Have repairs carried out only by a specialist.



Uncontrolled start-up on release of jammed pump
<i>Crushing, electric shock hazard</i>
<ul style="list-style-type: none"> • Disconnect the device from the mains before the repair. • Have repairs carried out only by a specialist.



Critical temperature of device parts, heat transfer liquid or accessories (hoses)
<i>Burns, scalds, frostbite</i>
<ul style="list-style-type: none"> • Bring the device parts, accessories and heat transfer liquid to room temperature before touching them. • Have repairs carried out only by a specialist. • Affix the symbol "Hot surface".

Fault	Possible remedy
Device does not cool	Dirty condenser → Clean condenser (⇒ 8.3.4). Temperature limit Til too high → Reduce temperature limit Til (⇒ 7.4.5).
Device does not heat up	Temperature limit Tih too low → Increase temperature limit Tih (⇒ 7.4.5).
Device does not pump	Check selector switch for proportioning external and internal pump flow (⇒ 6.1); pump blocked by foreign bodies.

8.5 Disposal information



The following applies for EU member states: The disposal of the device is regulated by EC Directive 2012/19/EU (WEEE Waste of Electrical and Electronic Equipment).

8.5.1 Disposal of the refrigerant

The refrigerant circuit is filled with the halogen-free hydrocarbon, propane.
The type and amount used are stated on the rating label. Repair and disposal are only to be carried out by specialists.

The Global Warming Potentials (GWP) [cf. CO ₂ = 1.0]	
Refrigerant	GWP _(100a) *
R-290	3

**according to IPCC IV - Time horizon 100 years*

8.5.2 Disposal of the packaging

The following applies for EU member states: The disposal of the packaging proceed according to the EC Directive 94/62/EC.

8.6 Taking the device out of service

The device must be taken out of service by a specialist.

Comply with the following safety information:



Contact with hot / cold heat transfer liquid
<i>Scalds, frostbite</i>
<ul style="list-style-type: none"> • Bring the heat transfer liquid to room temperature before draining. • Drain the device and any accessories (e.g. hoses) before packing thoroughly.



Skin contact with hot / cold surfaces
<i>Burns, frostbite</i>
<ul style="list-style-type: none"> • Bring the surfaces to room temperature before touching them.



Uncontrolled escape of refrigerant / explosion
<i>Crushing, impacts, cuts</i>
<ul style="list-style-type: none"> • No disposal with cooling circuit under pressure. • Only a specialist is permitted to take the device out of service.



Falling / toppling equipment
<i>Crushing of hands and feet, impacts</i>
<ul style="list-style-type: none"> • Use the handles (grip heating thermostats underneath the device).

Also note the following for cooling devices with natural refrigerant:



Draining the refrigerant circuit
<i>Escape of refrigerant / danger of explosion</i>
<ul style="list-style-type: none"> • Do not produce any flames nor sparks. • Do not dispose of any cooling circuit which is under pressure. • Only specialists are permitted to take the device out of service. • Comply with the directives when disposing of flammable refrigerant.

8.7 Ordering replacement parts / LAUDA Service

When ordering replacement parts, please state the serial number (rating label); this helps to avoid queries and incorrect deliveries.

Your contact for maintenance and expert service support.



LAUDA Service

Phone: +49 (0)9343 503-350 (English and German)

Fax: +49 (0)9343 503-283

E-mail service@lauda.de

We are available at any time for queries and ideas!

LAUDA DR. R. WOBSE GMBH & CO. KG

Laudaplatz 1

97922 Lauda-Königshofen

Germany

Phone: +49 (0)9343 503-0

Fax: +49 (0)9343 503-222

E-Mail info@lauda.de

Internet <http://www.lauda.de>

9 Accessories

Please take catalogue numbers for accessories from the following table.

Immersion thermostats

Accessories	Suitable for	Catalogue number
Cooling coil set (small)	ECO GOLD, bath vessels up to 6 liters	LCZ 0720
Cooling coil set (large)	ECO GOLD, bath vessels from 6 liters	LCZ 0721
Pump connection set (outflow and return nozzles) with fitting 13 mm (plastic)	ECO GOLD	LCZ 0716
Pump connection set (pressure and return nozzles) with thread M16 x 1 (stainless steel) 2 fittings, 2 union nuts	ECO GOLD	LCZ 0717

Bath vessels	Material	Maximum temperature in °C	Volume L max.	Internal dimensions mm x mm x mm (W x D x H)	Catalogue number
6 T	Polycarbonate	100	6	130 x 420 x 160	LCZ 0703
12 T	Polycarbonate	100	12	300 x 315 x 160	LCZ 0704
15 T	Polycarbonate	100	15	416 x 130 x 310	LCZ 0705
20 T	Polycarbonate	100	20	300 x 490 x 160	LCZ 0706
B 4	Stainless steel	200	4	135 x 240 x 150	LCZ 0707
B 10	Stainless steel	200	11	300 x 329 x 150	LCZ 0708
B 15	Stainless steel	200	16	300 x 329 x 200	LCZ 0709
B 20	Stainless steel	200	19	300 x 505 x 150	LCZ 0710
B 25	Stainless steel	200	25	300 x 505 x 200	LCZ 0711
B 40	Stainless steel	200	40	300 x 750 x 200	LCZ 0712

Heating thermostats

Accessories	Suitable for	Catalogue number
Pump connection set (outflow and return nozzles) with fitting 13 mm (plastic)	All heating thermostats	LCZ 0716
Pump connection set (outflow and return nozzles) with thread M16 x 1 (stainless steel)	All heating thermostats	LCZ 0717
Bath cover in stainless steel	E 10 G	HDQ 169
Bath cover in stainless steel	E 20 G, E 25 G	HDQ 170
Bath cover in stainless steel (three-part)	E 40 G	LCZ 0718
Cooling coil set for ET 15	ET 15 G	LCZ 0719

Cooling thermostats

Accessories	Suitable for	Catalogue number
Pump connection set (outflow and return nozzles) with fitting 13 mm (plastic)	All cooling thermostats	LCZ 0716

For all devices

Accessories	Catalogue number
USB 2.0 cable (USB A male to mini B)	EKS 089
Upper module receptacle approx. 57 mm x 27 mm	
Analog module	LRZ 912
RS 232/485 interface module	LRZ 913
Contact module with 1 input and 1 output	LRZ 914
Contact module with 3 inputs and 3 outputs	LRZ 915
Profibus module	LRZ 917
Ethernet USB interface module	LRZ 921
LiBus interface box	LCZ 9727
Upper module receptacle approx. 57 mm x 17 mm	
Remote control unit Command*	LRT 927
External Pt100/LiBus module	LRZ 918
LiBus interface module	LRZ 920

* functions only in conjunction with LRZ 918

10 Technical data and graphs

The figures were determined according to DIN 12876.

Data applicable to all ECO GOLD thermostats		
Ambient temperature range	°C	5 – 40
Relative humidity		Maximum relative humidity 80 % at 31 °C and decreasing linearly to 50 % up to 40 °C.
Contamination level		2
Setting resolution	K	±0.01
Display resolution	K	±0.01
Accuracy of indication	K	±0.2
Pump type/number of power levels		Pressure pump/6
Discharge pressure, max.	bar	0.55
Discharge flow, max.	L/min	22
Viscosity of the heat carrier liquid	mm ² /s	Heating range: maximum 150; Control range: ≤ 30
Display field		TFT display 3.5"; 320 x 240 pixel
Programmer		5 programs with a total of 150 temperature/time segments
Standard interface		USB
Class of protection		IP 21
Class designation		III
Marking		FL (suitable for flammable and non-flammable liquids)
Overvoltages		Overvoltage Category II and transient overvoltages according to Category II.
Class of protection for electrical operating equipment DIN EN 61140 (VDE 0140-1)		Class I

Immersion thermostats

ECO GOLD		230 V	220 V	115 V	100 V
Working temperature range ①	°C	20 – 200			
Working temperature range with water cooling	°C	20 – 200			
Operating temperature range ②	°C	-20 – 200			
Temperature stability	K	±0.01			
Heater rating	kW	2.6	2.4	1.3	1.0
Heater surface loading	W/cm ²	6.8	6.2	6.8	5.1
Power consumption	kW	2.7	2.5	1.4	1.1
Bath depth	mm	At least 150			
Overall dimensions (W x D x H)	mm	130 x 135 x 325			
Weight	kg	3.4	3.4	3.0	3.0
Mains connection					
230 V ±10 %; 50/60 Hz		X	---	---	---
220 V ±10 %; 60 Hz		---	X	---	---
115 V ±10 %; 60 Hz		---	---	X	---
100 V ±10 %; 50/60 Hz		---	---	---	X

① at Pump power level 1

② with extraneous cooling

Heating thermostats with stainless steel bath						
		E 4 G	E 10 G	E 20 G	E 25 G	E 40 G
Working temperature range ①	°C	20 – 200				
Working temperature range with water cooling	°C	20 – 200				
Operating temperature range ②	°C	-20 – 200				
Temperature stability	K	±0.01				
Bath volume	L	3 – 3.5	7.5 – 11	13 – 19	16 – 25	32 – 40
Bath vessels		Inner tank in deep-drawn stainless steel 1.4301 conforming to SAE 30304 AISI 304				
Outer jacket		Powder-coated steel sheet				
Bath opening (B x T)	mm	135 x 105	300 x 190	300 x 365	300 x 365	613 x 300
Bath depth	mm	150	150	150	200	200
Usable bath depth	mm	130	130	130	180	180
Height of bath edge without cover	mm	196	196	196	246	248
Overall dimensions (W x D)	mm	168 x 272	331 x 361	331 x 537	331 x 537	350 x 803
Overall height (H)	mm	376	376	376	426	428
Pump connection Stainless steel fittings 13 mm (thread M16 x 1)		Standard	③ Optional accessory			
230 V ±10 %; 50/60 Hz						
Heater rating / power consumption	kW	2.6 / 2.7				
Weight	kg	7.0	9.0	12.2	13.5	17.6
220 V ±10 %; 60 Hz						
Heater rating / power consumption	kW	2.4 / 2.5				
Weight	kg	7.0	9.0	12.2	13.5	17.6
115 V ±10 %; 60 Hz						
Heater rating / power consumption	kW	1.3 / 1.4				
Weight	kg	6.6	8.6	11.8	13.1	17.2
100 V ±10 %; 50/60 Hz						
Heater rating / power consumption	kW	1.0 / 1.1				
Weight	kg	6.6	8.6	11.8	13.1	17.2

① at Pump power level 1

② with extraneous cooling

③ Optional accessory

Heating thermostats with transparent bath					
		ET 6 G	ET 12 G	ET 15 G	ET 20 G
Working temperature range ①	°C	20 – 100			
Working temperature range with water cooling	°C	20 – 100			
Operating temperature range ②	°C	-20 – 100			
Temperature stability	K	±0.01			
Bath volume	L	5 – 6	9.5 – 12	13.5 – 15	15 – 20
Bath vessels		Polycarbonate			
Usable bath opening (W x D) with control head	mm	130 x 285	300 x 175	275 x 130	300 x 350
Bath depth	mm	160	160	310	160
Usable bath depth	mm	140	140	290	140
Height of bath edge without cover	mm	169	208	356	208
Overall dimensions (W x D)	mm	143 x 433	322 x 331	428 x 148	322 x 506
Overall height (H)	mm	349	389	532	389
Pump connection Stainless steel fittings 13 mm (thread M16 x 1)		③ Optional accessory	③ Optional accessory	Standard	③ Optional accessory
230 V ± 10 %; 50/60 Hz					
Heater rating / power consumption	kW	2.6 / 2.7			
Weight	kg	4.5	6.8	6.8	8.0
220 V ± 10 %; 60 Hz					
Heater rating / power consumption	kW	2.4 / 2.5			
Weight	kg	4.5	6.8	6.8	8.0
115 V ± 10 %; 60 Hz					
Heater rating / power consumption	kW	1.3 / 1.4			
Weight	kg	4.1	6.4	6.4	7.6
100 V ± 10 %; 50/60 Hz					
Heater rating / power consumption	kW	1.0 / 1.1			
Weight	kg	4.1	6.4	6.4	7.6

① at Pump power level 1

② with extraneous cooling

③ Optional accessory

Cooling thermostats (1) with natural refrigerant					
			RE 415 G	RE 420 G	RE 630 G
Working temperature - ACC range*		°C	-15 – 200	-20 – 200	-30 – 200
Ambient temperature range		°C	5 – 40		
Temperature stability		K	±0.02		
Maximum storage temperature		°C	43		
Cooler			Air		
Refrigerant			R-290		
Cooling output at 20 °C ambient temperature, 15 °C cooling water temperature, 3 bar cooling water pressure and Pump stage 2	20 °C	W	180	200	300
	10 °C	W	160	180	270
	0 °C	W	120	150	240
	-10 °C	W	80	100	190
	-15 °C	W	30	---	---
	-20 °C	W	---	30	100
	-30 °C	W	---	---	20
Bath volume		liters	3.3 – 4	3.3 – 4	4.6 – 5.7
Bath opening (W x D)		mm	130 x 105	130 x 105	150 x 130
Bath depth		mm	160		
Usable depth		mm	140		
Height to top edge of bath		mm	365	374	400
Overall dimensions (W x D)		mm	180 x 350	180 x 396	200 x 430
Overall height (H)		mm	546	555	581
Sound level (1 m)		dB(A)	50		
Pump connection			Stainless steel fittings 13 mm (thread M16 x 1)		
			Heater rating / power consumption		
230 V ±10 %; 50 Hz		kW	2.6 / 2.8	2.6 / 2.8	2.6 / 2.9
Weight		kg	20.0	22.0	27.6

*ACC range (Active Cooling Control) according to DIN 12876 is the working temperature range for operation with an active refrigerating machine

Cooling thermostats (2) with natural refrigerant					Calibration thermos.	
			RE 1225 G	RE 2025 G	RE 1050 G	RE J 1225 G
Operating temperature, ACC *	°C		-25 – 200	-25 – 200	-50 – 200	-25 – 200
Ambient temperature range	°C		5 – 40			
Temperature stability	K		±0.02			
Maximum storage temperature	°C		43			
Cooler			Air			
Refrigerant			R-290			
Cooling output at 20 °C ambient temperature, 15 °C cooling water temperature, 3 bar cooling water pressure and Pump Level 2	20 °C	W	300	300	700	300
	10 °C	W	270	260	660	270
	0 °C	W	240	230	600	240
	-10 °C	W	180	150	520	180
	-20 °C	W	90	60	350	90
	-25 °C	W	40	30	---	40
	-30 °C	W	---	---	190	---
	-40 °C	W	---	---	100	---
	-50 °C	W	---	---	20	---
Bath volume	liters		9.3 – 12	14 – 20	8 – 10	9.3 – 12
Bath opening (W x D)	mm		200 x 200	300 x 350	200 x 200	Ø 150
Bath depth	mm		200	160	160	200
Usable depth	mm		180	140	140	180
Height to top edge of bath	mm		443			
Overall dimensions (W x D)	mm		250 x 435	350 x 570	280 x 440	250 x 435
Overall height (H)	mm		624			
Sound level (1 m)	dB(A)		50	50	52	50
Pump connection			Stainless steel fittings 13 mm (thread M16 x 1)			
			Heater rating / power consumption			
230 V ±10 %; 50 Hz	kW		2.6 / 2.9	2.6 / 2.9	2.6 / 3.3	2.6 / 2.9
Weight	kg		30.4	37.4	35.0	31.5

*ACC range (Active Cooling Control) according to DIN 12876 is the working temperature range for operation with an active refrigerating machine

Technical modifications reserved!

Pump characteristic ECO GOLD

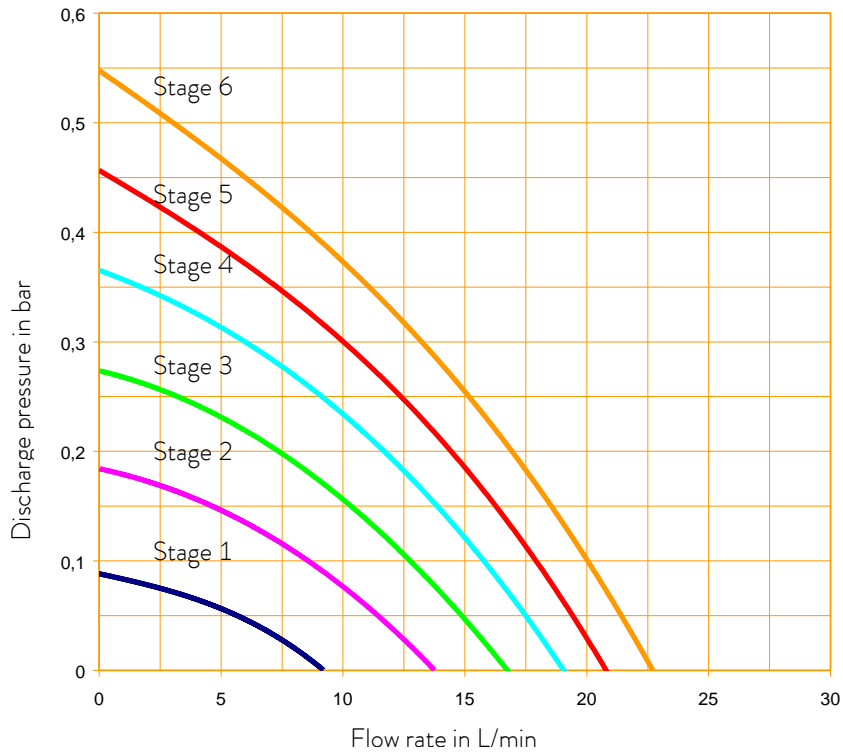

Pump characteristics measured with water

Heating curve for ECO GOLD heating thermostats with transparent bath

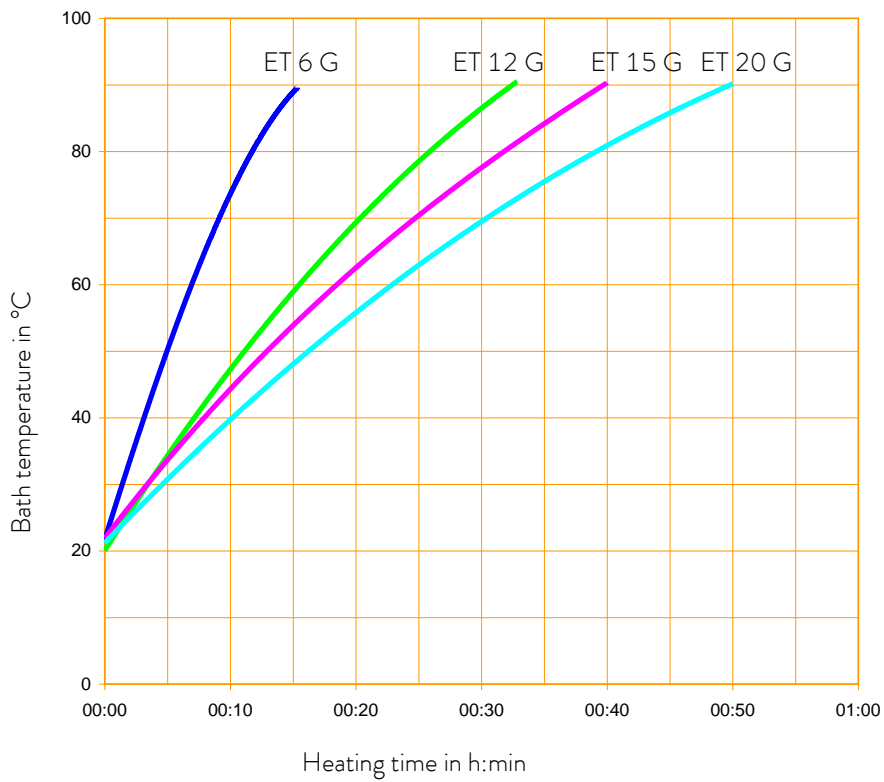

Heat transfer liquid: Water, bath closed

Heating curve for ECO GOLD heating thermostats with stainless steel bath

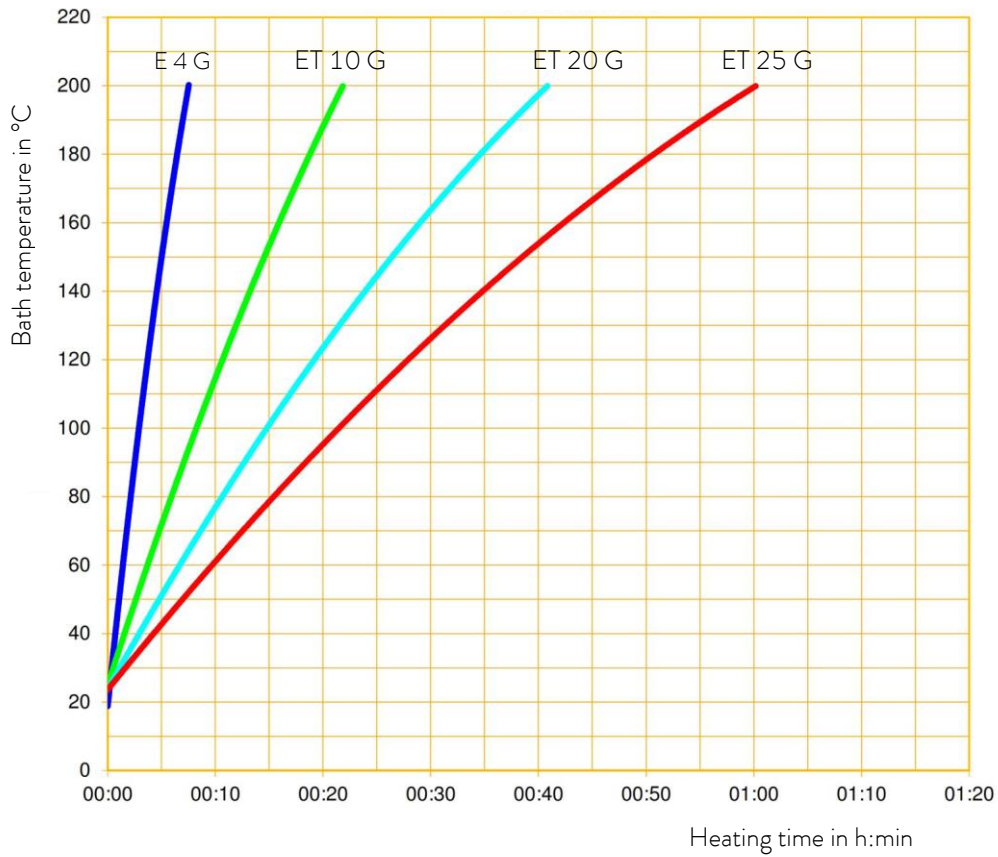

Cooling curves for ECO cooling thermostats

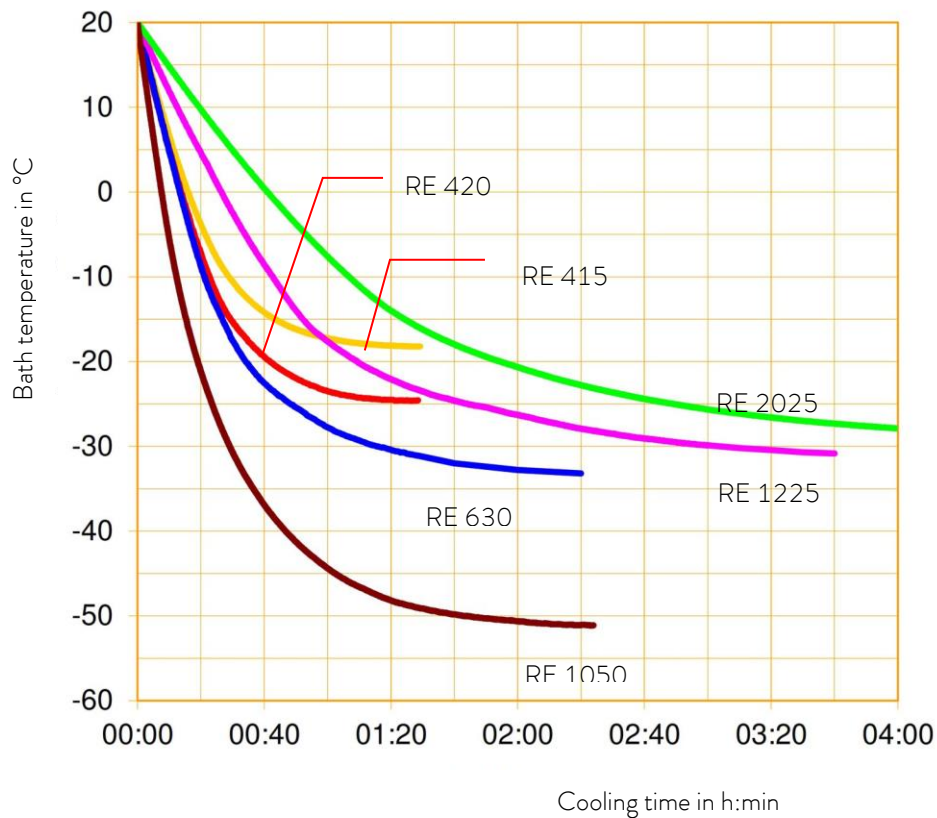

11 Declaration of Conformity



EC DECLARATION OF CONFORMITY

Manufacturer: LAUDA DR. R. WOBSEY GMBH & CO. KG
Laudaplatz 1, 97922 Lauda-Königshofen, Germany

We hereby declare under our sole responsibility that the machines described below

Product Line: ECO **Serial number:** from S210000001

Types: E4 S, E 4 G, E 10 S, E 10 G, E 20 S, E 20 G, E 25 S, E 25 G, E 40 S, E 40 G
ET 6 S, ET 6 G, ET 12 S, ET 12 G, ET 15 S, ET 15 G, ET 20 S, ET 20 G

comply with all relevant provisions of the EC Directives listed below due to their design and type of construction in the version brought on the market by us:

Machinery Directive	2006/42/EC
EMC Directive	2014/30/EU
RoHS Directive	2011/65/EU in connection with (EU) 2015/863

The equipment is not covered by the Pressure Equipment Directive 2014/68/EU, as the maximum classification of the equipment is Category 1 and it is covered by the Machinery Directive.

The protective objectives of the Machinery Directive with regard to electrical safety are complied with in accordance with Annex I Paragraph 1.5.1 in conformity with the Low Voltage Directive 2014/35/EU.

Applied standards:

- EN ISO 12100:2010
- EN 61326-1:2013
- EN 61010-1:2010/A1:2019/AC:2019-04
- EN 61010-2-010:2014

Authorized representative for the composition of the technical documentation:

Dr. Jürgen Dirscherl, Head of Research & Development

Lauda-Königshofen, 28.10.2021

Dr. Alexander Dinger, Head of Quality Management

EC DECLARATION OF CONFORMITY

Manufacturer: LAUDA DR. R. WOBSEER GMBH & CO. KG
Laudaplatz 1, 97922 Lauda-Königshofen, Germany

We hereby declare under our sole responsibility that the machines described below

Product Line: ECO **Serial number:** from S210000001

Types: RE 415 S, RE 415 G, RE 415 SW, RE 415 GW, RE 420 S, RE 420 G,
RE J 1225 G, RE 630 S, RE 630 G, RE 1050 S, RE 1050 G,
RE 1225 S, RE 1225 G, RE 2025 S, RE 2025 G

comply with all relevant provisions of the EC Directives listed below due to their design and type of construction in the version brought on the market by us:

Machinery Directive	2006/42/EC
EMC Directive	2014/30/EU
RoHS Directive	2011/65/EU In connection with (EU) 2015/863

The equipment is not covered by the Pressure Equipment Directive 2014/68/EU, as the maximum classification of the equipment is Category 1 and it is covered by the Machinery Directive.

The protective objectives of the Machinery Directive with regard to electrical safety are complied with in accordance with Annex I Paragraph 1.5.1 in conformity with the Low Voltage Directive 2014/35/EU.

Applied standards:

- EN ISO 12100:2010
- EN 61326-1:2013
- EN 378-2:2018
- EN 61010-1:2010/A1:2019/AC:2019-04
- EN 61010-2-010:2014

Authorized representative for the composition of the technical documentation:

Dr. Jürgen Dirscherl, Head of Research & Development

Lauda-Königshofen, 28.10.2021



Dr. Alexander Dinger, Head of Quality Management

12 Index

A

Acoustic signals	85
Alarms	55, 56, 90
Ambient temperature	68
Analog module	14, 110
Assembly	24
Autostart	86

C

Calibration	87
Calibration thermostat	
Maintenance	29
Starting up	29
Chiller	14, 85
Circuit breaker	40
Cleaning	59
Condenser	61
Contact Module	14, 126
Control panel	17
Control parameters	104
Cooling Coil	25
Cooling curves	75
Cooling thermostat	27
Cooling water	36
Cooling, heating thermostats	40
Correcting quantity limit	106
Curr.Consumpt.	87
Cursor keys	17

D

Damping time	104, 106
Derivative time	104, 106
Device data	57
Device status	57
Device type	58
Display brightness	86
Disposal	37, 63
Drain tap	35

E

EMC standard DIN EN 61326-1	8
Emptying	34
Error	55
Error messages	55
Error store	57
EXT	30
External control	96
External load	26
External temperature sensor	14

F

Factory calibration	88
Factory settings	84
Fault finding	62
Filling	34
Flow distribution	33
Flow distribution (pump)	30

G

Gain	106
Graphical display	93
Graphics window	51

H

Heat transfer liquid	
changing	35
draining	35
Heat transfer liquids	36, 60
Heating curve	74, 75
Heating thermostat	26
Hoses	36

I

Immersion thermostat	25
INT	30
Interfaces	14

K

Key lock	89
----------------	----

Kpe.....	106	Servicing.....	59
L		Servicing intervals.....	60
Labview.....	124	Setpoint offset.....	97
Language	54	Set-point, bath temperature	52
LiBus.....	113	Setting the date	54
Loops	103	Setting the time	54
Low level.....	56	Soft key.....	17
M		Software version	58
Mains connection.....	40	Standby	53
Maintenance	55	Starting mode.....	86
Menu structure.....	47	T	
O		Td104	
Online graph.....	93	Tde.....	106
Operating controls.....	16	Technical data.....	68
Operation.....	43	Temperature	
Ordering replacement parts	65	ambient temperature.....	24
Overtemperature protection	55	room temperature.....	24
Overtemperature switch-off point.....	17, 51	set-point value	52
P		Temperature limits	53
Profibus Module.....	14	Tmax	51
Programmer.....	98	Tn104	
Prop_E.....	106	Tne.....	106
Proportional range.....	104, 106	Tv104	
Pt100/LiBus module.....	114	Tve.....	106
Pump.....	13	U	
Pump characteristic.....	74	UK plugs.....	40
Pump Connection Set.....	31	Unpacking.....	22
Pump level.....	52	USB interface.....	13, 115
R		V	
Repair	59	Viscosity.....	68
Reset time.....	104, 106	W	
RS 232/485 interface module.....	14, 111	Warnings	55, 90
S		X	
Safety information.....	7	Xp.....	104
Screw clamp.....	25	Xpf.....	106
Serial numbers	58		

Appendix with settings

The adjustments described in this appendix are only intended for specially qualified personnel.

13 Other settings

13.1 Resetting to factory settings

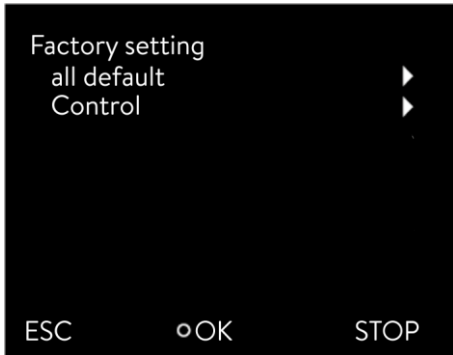



- Access to the main menu level is obtained by pressing the enter key .
- Selection and confirmation of → **Setup** → **Factory Setting**.

The adjacent menu window appears.

- Select the menu item **all default**.

Select one of the following options:

- Selecting **no** returns to the previous display without making any changes.
- Selecting **yes** restores the factory settings if you confirm this with the enter key.
- By selecting **Control** you can select the displayed parameters with  or .

Select the appropriate menu item in the parameter list.

- The internal and the external control parameters can be reset using **Control parameter**.
- The settings for the internal sensor can be reset with **internal Pt100**.
- With **miscellaneous** the following can be reset: set value, pump level, max. current consumption, control to internal and auto-start to "auto".

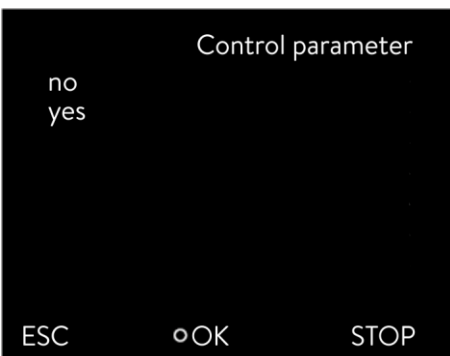

Select one of the following options:

- Selecting **no** returns to the previous display without making any changes.
- Selecting **yes** resets the selected parameter if you confirm this with the enter key.

- By pressing  or  (ESC) you are returned to the menu level without any change.

13.2 Setting the volume of the acoustic signals

The ECO GOLD thermostats sound alarms and faults as a two-tone acoustic signal. Warnings are signaled as a continuous tone,



- Access to the main menu level is obtained by pressing the enter key .
- Selection and confirmation of → Setup → Basic setup → Sounds.
- Choose Alarm, Warn or Error.

The adjacent menu window appears.

- The volume is selected with  or . The selected level is immediately active without confirmation.

- By pressing ,  or  you are returned to the menu level without any change.

13.3 Setting the chiller

The chiller of the cooling thermostats is operated in the "automatic" operating mode as standard. Here, the cooling unit switches on or off automatically depending on the temperature and operating status. However, you can also switch the cooling unit on or off manually.





- Access to the main menu level is obtained by pressing the enter key .



- Selection and confirmation of → Setup → Cooling.

The adjacent menu window appears.

- (As well as Cooling the current operating mode is stated. This is "off", "on" or "automatic".)
- Select Cooling with .

- With  or  and  you select and confirm the operating status "off", "on" or "automatic".

- In the menu the set operating status is displayed by a tick .





- By pressing  or  (ESC) you are returned to the menu level without any change.

Note: When the cooling unit is switched off, it can take up to two minutes before it switches on again.



13.4 Setting the display brightness

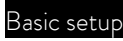

The ECO range of thermostats have a sensor which automatically adapts the display brightness according to the ambient light level. However, the automatic adaptation can be deactivated and the brightness set manually.



- Access to the main menu level is obtained by pressing the enter key .
- Selection and confirmation of    .

The adjacent menu window appears.



- Select "automatic", "level" or "off" with  or . The selected level is immediately active without confirmation.

- By pressing ,  or  you are returned to the menu level without any change.

13.5 Defining the starting mode (Autostart)

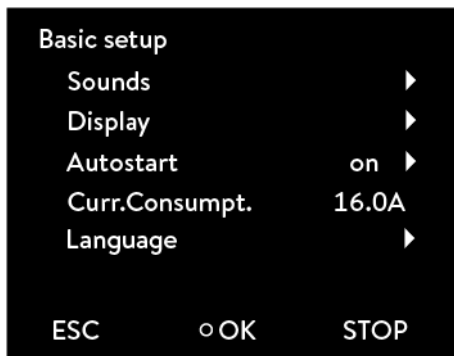
Generally, it is required that the thermostat starts operating again after a power interruption. For reasons of safety, for example, you can insert a manual activation step.



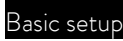

- Access to the main menu level is obtained by pressing the enter key .
- Selection and confirmation of  .

The adjacent menu window appears. As well as  the current setting is stated. This is "off" or "on"

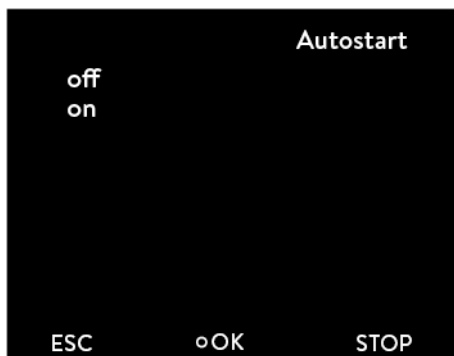
- Select  with .



- Select the operating status "off" or "on" with  or  and confirm with .

If "off" is selected, standby operation is activated after a mains interruption.

With the setting "on" the device continues running straight after the mains interruption.

- By pressing  or  you are returned to the menu level without any change.

13.6 Limiting the mains current consumption

If your mains fusing is below 16 A, the current consumption can be reduced in steps from 16 A to 8 A. The maximum heating power is reduced correspondingly. Here, take into consideration whether other loads are connected to the same fused circuit or whether your ECO thermostat is the only load.

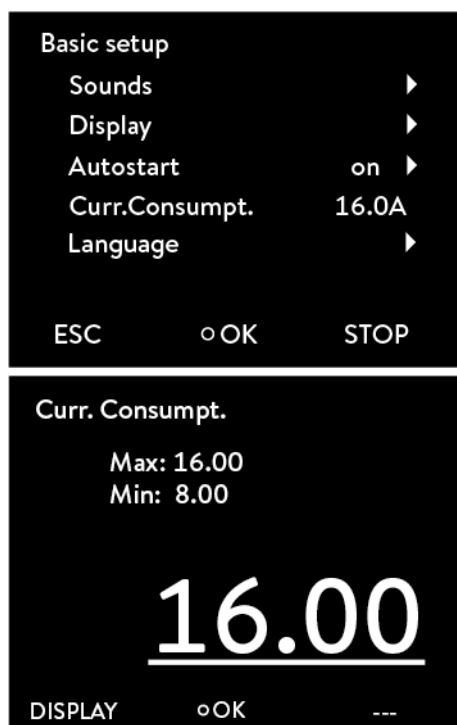



- Access to the main menu level is obtained by pressing the enter key .

- Selection and confirmation of  Setup  Basic setup.

The adjacent menu window appears.

- As well as Curr.Consumpt. the set value is displayed.

- Select Curr.Consumpt. with .

- Change the value with  or .

- Single figures can be selected by pressing  or .

- Confirm the input with the enter key .

- By pressing  (ESC) you are returned to the menu level without any change.

13.7 Entering the offset of the displayed temperature (calibration)

Deviations to the calibrated reference thermometers (e.g. LAUDA DigiCal) can be corrected internally by the "Off-set" function.

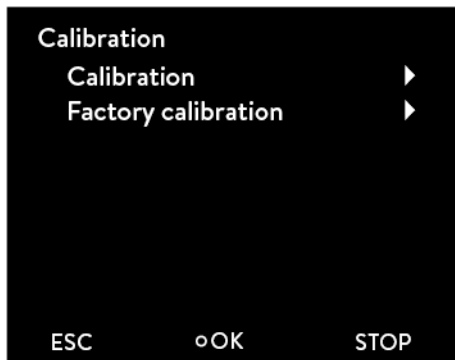

- Access to the main menu level is obtained by pressing the enter key .





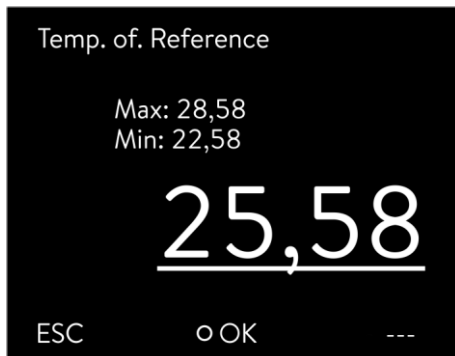

- Selection and confirmation of → Setup → Calibration.

The adjacent menu window appears.

- Select Calibration with  or  and confirm with .



The entry window appears. The value indicated on the reference thermometer must be entered as the value.

- Change the value with  or .
- Single figures can be selected by pressing  or .
- By pressing  (+/-) the arithmetic sign can be changed.
- You confirm the set value by pressing .

- By pressing  (ESC) you are returned to the menu level without any change.

13.8 Restoring the factory setting of the internal temperature sensor

If the offset has been adjusted, the factory setting can be restored again.

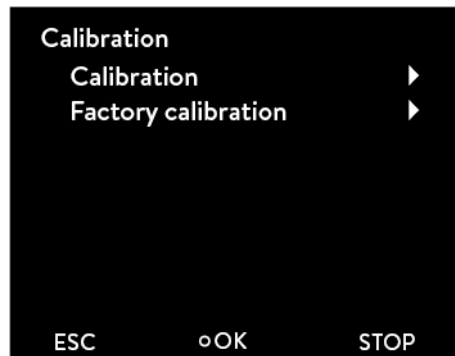

- Access to the main menu level is obtained by pressing the enter key .

- Selection and confirmation of → Setup → Calibration.

The adjacent menu window appears.

- Select and confirm Factory calibration with  or  and .

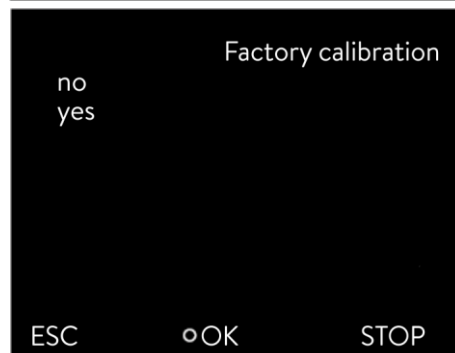

The adjacent menu window appears.

- Select "yes" using  or  and confirm with  to restore the factory settings.

- By pressing "no"  (ESC) or  you are returned to the menu level without any change.

13.9 Key lock



The entry key and arrow keys on the control panel on the device can be locked.

This can be done directly using the control keys on the device or by using write commands provided by an interface module (for example RS 232/485 module, Ethernet USB module, or contact module).

When the device is being controlled using a process control system, it is important to be able to lock the control keys on the device.

Activating the key lock with the control keys:

It is possible to lock the keys when it is in "standby" or "running" operating mode and the home screen or graph window is displayed.

- Press the input key  and keep it pressed.
- Press the **down** key  and keep it pressed.
- After four seconds, the key lock is activated.

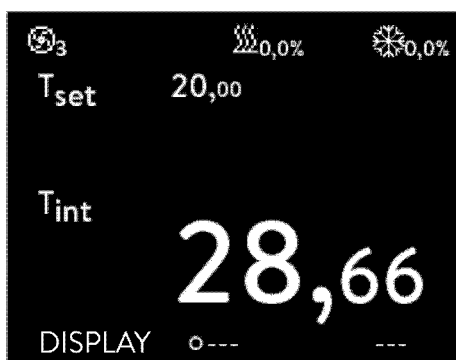



In the softkey bar, the middle softkey, "Menu", and the softkey on the right, "Standby", are hidden. The functions associated with them are no longer available.

The softkey on the left continues working. This is used to switch the display between the home screen and the graph window.

The overtemperature switch-off point can be viewed, but not changed, using the Tmax  key.

Deactivating the key lock with the control keys:

- Press the input key  and keep it pressed.
- Press the **up** key  and keep it pressed.
- After four seconds, the key lock is deactivated.

The functions associated with the softkey bar and the Tmax key are all available again.

14 List of "Alarm and warning codes"

Alarms

Alarm code		Meaning
1	Low Level Pump	Pump runs too fast (low level)
2	Low Level Pump	Low level in the float
3	Overtemperature	Overtemperature ($T > T_{max}$)
4	Pump blocked	Pump blocked (standstill)
5	Connection Command	Remote control unit command triggered in running operation
9	T ext Pt100	External Pt100 actual value is not present.
10	T ext analog	External analog actual value is not present.
11	T ext serial	External serial actual value is not present.
12	Input Analog 1	Analog module: Current interface 1, interruption.
13	Input Analog 2	Analog module: Current interface 2, interruption.
15	Digital Input	Error on digital input

Warnings

Code	OXX Control system	Meaning	Code	3XX SmartCool	Meaning
1	CAN receive overf	Overflow during CAN reception	1	CAN receive overf	Overflow during CAN reception
2	Watchdog Reset	Watchdog reset	2	Watchdog Reset	Watchdog reset
3	T_il limit active	til lmit active	3	adaption missing	No adaption run
4	T_ih limit active	tih llmit active	4	Pressure switch activated	Pressure Switch in cooling circuit triggered
5	corrupt parameter	Inadmissible internal parameter	5	Clean condenser	Clean condenser
6	corrupt progr	Inadmissible programmer data	6	TO1 out of range (Klixon)	Injection temperature outside value range
7	Invalid Parameter	Inadmissible parameter in memory	7	Invalid Parameter	Inadmissible parameter in memory
8	CAN system	Problem during internal data interchange	8	CAN system	Problem during internal data interchange
9	Unknown Modul	Unknown module connected	9	Unknown Modul	Unknown module connected
10	SW control too old	Software version of control panel too old	10	SW control too old	Software version of control panel too old
11	SW safety too old	Software version of protection too old	11	SW safety too old	Software version of protection too old
12	SW command too old	Software version of command remote control unit too old	12	SW command too old	Software version of command remote control unit too old
13	SW cool too old	Software version of cooling module too old	13	SW cool too old	Software version of cooling module too old
14	SW analog too old	Software version of analog too old	14	SW analog too old	Software version of analog too old
15	SW serial too old	Software version of serial too old	15	SW serial too old	Software version of RS 232 too old
16	SW contact old	Software version of contact module too old	16	SW contact old	Software version of contact module too old
17	SW Valve 0 old	Software version of solenoid valve too old	17	SW Valve 0 old	Software version of solenoid valve 0 too old
18	SW Valve 1 old	Software version of solenoid valve 1 too old	18	SW Valve 1 old	Software version of solenoid valve 1 too old
19	SW Valve 2 old	Software version of solenoid valve 2 too old	19	SW Valve 2 old	Software version of solenoid valve 2 too old
20	SW Valve 3 old	Software version of solenoid valve 3 too old	20	SW Valve 3 old	Software version of solenoid valve 3 too old
21	SW Valve 4 old	Software version of solenoid valve 4 too old	21	SW Valve 4 old	Software version of solenoid valve 4 too old
26	SW HTC old	Software version of high temperature cooler too old	26	SW HTC old	Software version of high temperature cooler too old
27	SW Ext Pt100 old	Software version of external Pt100 too old	27	SW Ext Pt100 old	Software version of external Pt100 too old
33	RTC wrong data	Internal clock defective	33	valve sm0 break	Cable of injection valve 0 defective
41	wrong net voltage	Incorrect mains voltage setting	34	valve sm1 break	Cable of injection valve 1 defective
42	no eco type	Device type not configured	35	valve sm2 break	Cable of injection valve 2 defective
43	no eco voltage	Mains voltage not configured	36	valve sm3 break	Cable of injection valve 3 defective
44	chiller missing	Chiller not running	37	output sm0	Triggering of injection valve 0 defective
45	Diff.voltages	Different mains voltage configured (head and cooling underpart)	38	output sm1	Triggering of injection valve 1 defective
	# of heaters	Setting the heater configuration	39	output sm2	Triggering of injection valve 2 defective
			40	output sm3	Triggering of injection valve 3 defective

			41	sm0 min too small	Start value of injection valve too small
			42	no eco type	Device type not configured
			43	no eco voltage	Mains voltage not configured
			44	chiller missing	Chiller not running

Code	1XX Safety system	Meaning	Code	2XX Command	Meaning
1	CAN receive overf	Overflow during CAN reception	1	CAN receive overf	Overflow during CAN reception
2	Watchdog Reset	Watchdog reset	2	Watchdog Reset	Watchdog reset
5	Heat 1 failed	Heater 1 defective	3	Clock Error	Battery fault
6	Heat 2 failed	Heater 2 defective	9	Unknown Modul	Unknown module connected
7	Invalid Parameter	Inadmissible parameter in memory	10	SW control too old	Software version of control panel too old
8	CAN system	Problem during internal data interchange	11	SW safety too old	Software version of protection too old
9	Unknown Modul	Unknown module connected	12	SW command too old	Software version of command remote control unit too old
10	SW control too old	Software version of control panel too old	13	SW cool too old	Software version of cooling module too old
11	SW safety too old	Software version of protection too old	14	SW analog too old	Software version of analog too old
12	SW command too old	Software version of command remote control unit too old	15	SW serial too old	Software version of RS 232 too old
13	SW cool too old	Software version of cooling module too old	16	SW contact old	Software version of contact module too old
14	SW analog too old	Software version of analog too old	17	SW Valve 0 old	Software version of solenoid valve 0 too old
15	SW serial too old	Software version of RS 232 too old	18	SW Valve 1 old	Software version of solenoid valve 1 too old
16	SW contact old	Software version of contact module too old	19	SW Valve 2 old	Software version of solenoid valve 2 too old
17	SW Valve 0 old	Software version of solenoid valve 0 too old	20	SW Valve 3 old	Software version of solenoid valve 3 too old
18	SW Valve 1 old	Software version of solenoid valve 1 too old	21	SW Valve 4 old	Software version of solenoid valve 4 too old
19	SW Valve 2 old	Software version of solenoid valve 2 too old	26	SW HTC old	Software version of high temperature cooler too old
20	SW Valve 3 old	Software version of solenoid valve 3 too old			
21	SW Valve 4 old	Software version of solenoid valve 4 too old			
26	SW HTC old	Software version of high temperature cooler too old			
27	SW Ext Pt100 old	Software version of external Pt100 too old			

Code	4XX Analog module	Meaning	Code	5XX Serial (RS 232/485)	Meaning
1	CAN receive overf	Overflow during CAN reception	1	CAN receive overf	Overflow during CAN reception
2	Watchdog Reset	Watchdog reset	2	Watchdog Reset	Watchdog reset
9	Unknown Modul	Unknown module connected	9	Unknown Modul	Unknown module connected
10	SW control too old	Software version of control panel too old	10	SW Contr. too old	Software version of control panel too old
11	SW safety too old	Software version of protection too old	11	SW safety too old	Software version of protection too old
12	SW command too old	Software version of command remote control unit too old	12	SW command too old	Software version of command remote control unit too old
13	SW cool too old	Software version of cooling module too old	13	SW cool too old	Software version of cooling module too old
14	SW analog too old	Software version of analog too old	14	SW analog too old	Software version of analog too old
15	SW serial too old	Software version of RS 232 too old	15	SW serial too old	Software version of RS 232 too old
16	SW contact old	Software version of contact module too old	16	SW contact old	Software version of contact module too old
17	SW Valve 0 old	Software version of solenoid valve 0 too old	17	SW Valve 0 old	Software version of solenoid valve 0 too old
18	SW Valve 1 old	Software version of solenoid valve 1 too old	18	SW Valve 1 old	Software version of solenoid valve 1 too old
19	SW Valve 2 old	Software version of solenoid valve 2 too old	19	SW Valve 2 old	Software version of solenoid valve 2 too old
20	SW Valve 3 old	Software version of solenoid valve 3 too old	20	SW Valve 3 old	Software version of solenoid valve 3 too old
21	SW Valve 4 old	Software version of solenoid valve 4 too old	21	SW Valve 4 old	Software version of solenoid valve 4 too old
26	SW HTC old	Software version of high temperature cooler too old	26	SW HTC old	Software version of high temperature cooler too old
27	SW Ext Pt100 old	Software version of external Pt100 too old	27	SW Ext Pt100 old	Software version of external Pt100 too old

Code	6XX Switch contacts	Meaning	Code	7, 8, 9, 10, 11, 16XX Solenoid valve	Meaning
1	CAN receive overf	Overflow during CAN reception	1	CAN receive overf	Overflow during CAN reception
2	Watchdog Reset	Watchdog reset	2	Watchdog Reset	Watchdog reset
9	Unknown Modul	Unknown module connected	3	No cooling liquid	No cooling liquid present (HTC)
10	SW Contr. too old	Software version of control panel too old	6	no unfill liquid too hot	No draining, because bath temperature is too hot (HTC)
11	SW safety too old	Software version of protection too old	9	Unknown Modul	Unknown module connected
12	SW command too old	Software version of command remote control unit too old	10	SW Contr. too old	Software version of control panel too old
13	SW cool too old	Software version of cooling module too old	11	SW safety too old	Software version of protection too old
14	SW analog too old	Software version of analog too old	12	SW command too old	Software version of command remote control unit too old
15	SW serial too old	Software version of RS 232 too old	13	SW cool too old	Software version of cooling module too old
16	SW contact old	Software version of contact module too old	14	SW analog too old	Software version of analog too old
17	SW Valve 0 old	Software version of solenoid valve 0 too old	15	SW serial too old	Software version of RS 232 too old
18	SW Valve 1 old	Software version of solenoid valve 1 too old	16	SW contact old	Software version of contact module too old
19	SW Valve 2 old	Software version of solenoid valve 2 too old	17	SW Valve 0 old	Software version of solenoid valve 0 too old
20	SW Valve 3 old	Software version of solenoid valve 3 too old	18	SW Valve 1 old	Software version of solenoid valve 1 too old
21	SW Valve 4 old	Software version of solenoid valve 4 too old	19	SW Valve 2 old	Software version of solenoid valve 2 too old
26	SW HTC old	Software version of high temperature cooler too old	20	SW Valve 3 old	Software version of solenoid valve 3 too old
27	SW Ext Pt100 old	Software version of external Pt100 too old	21	SW Valve 4 old	Software version of solenoid valve 4 too old
			26	SW HTC old	Software version of high temperature cooler too old
			27	SW Ext Pt100 old	Software version of external Pt100 too old

Code	17XX Pt100/LiBus Module	Meaning
1	CAN receive overf	Overflow during CAN reception
2	Watchdog Reset	Watchdog reset
3	Ext_Pt_short	Line short on external t100
7	Invalid Parameter	Inadmissible parameter in memory
8	CAN system	Problem during internal data interchange
9	Unknown Modul	Unknown module connected
10	SW Contr. too old	Software version of control panel too old
11	SW safety too old	Software version of protection too old
12	SW command too old	Software version of command remote control unit too old
13	SW cool too old	Software version of cooling module too old
14	SW analog too old	Software version of analog too old
15	SW serial too old	Software version of RS 232 too old
16	SW contact old	Software version of contact module too old
17	SW Valve 0 old	Software version of solenoid valve 0 too old
18	SW Valve 1 old	Software version of solenoid valve 1 too old
19	SW Valve 2 old	Software version of solenoid valve 2 too old
20	SW Valve 3 old	Software version of solenoid valve 3 too old
21	SW Valve 4 old	Software version of solenoid valve 4 too old
26	SW HTC old	Software version of high temperature cooler too old
27	SW Ext Pt100 old	Software version of external Pt100 too old

15 Graphical display of temperature measurements

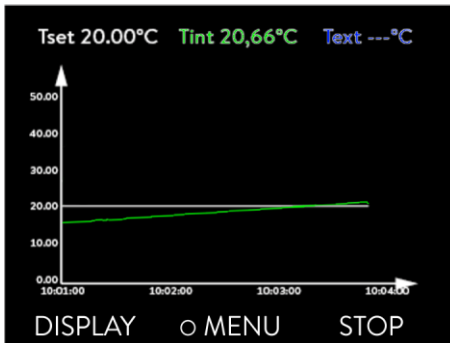

- From the main menu window you access the graphics window by pressing **DISPLAY**.

The temperature traces are shown in different colors.

- T_{set} set-point temperature (grey)
- T_{int} internal bath temperature (green).
- T_{ext} external bath temperature (blue).

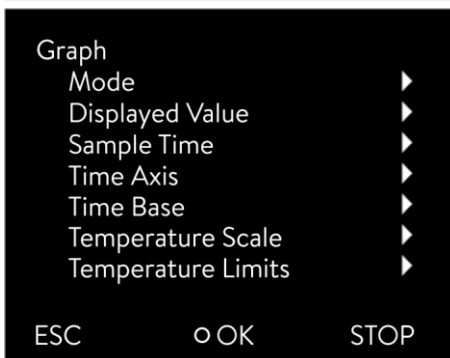

You can change the settings for the graphics window in the submenu **Graph**.

- Access to the menu level is obtained by pressing **OK**.
- Select and confirm **Graph** in main menu with **UP** or **DOWN** and **OK**.

The adjacent menu window appears.

- With **LEFT** or **RIGHT** you quit the respective window without changes.
- All menu points are selected with **UP** or **DOWN** and confirmed with **OK**.

In the following the individual menu points of the menu window "Graph" are described.

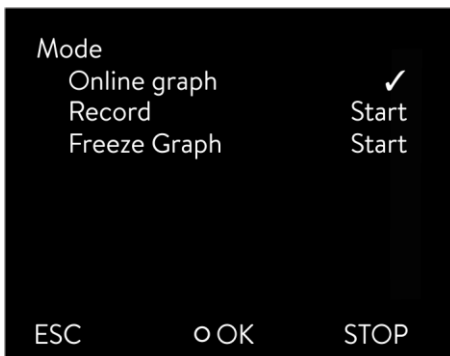

In the menu **Mode** there are the following settings:

- **Online graph** Recording runs continuously.
- **Recording Start** Start or stop recording
- **Recording Stop**
- **Freeze Graph Start** Save current recording.



With display **Measurements** you can define which temperature values are to be graphically displayed.

Numerous combinations are offered in the menu (see illustration).

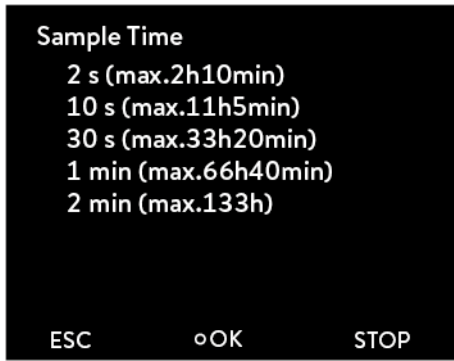

With **Rec. Interval** you define the time interval between recorded temperature measurements (the values in brackets state the maximum recording time).

The menu offers five options.

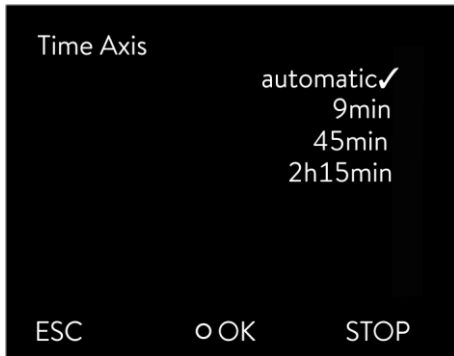

With **Time axis** you can define the temporal range over which the measurements are to be displayed.

- **automatic** Program optimized display
- **9 min** time axes set manually
- **45 min** (depending on recording interval up to 144 h)
- **2 h 15 min**



You can set the scaling to be used via the menu point **Time base**.

- **absolute** Reference current time
- **relative** Start time "00:00:00"

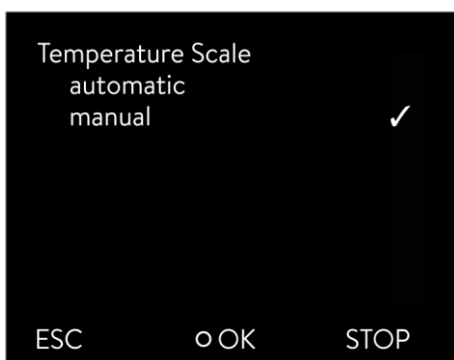

With **Temperature Scale** you can define the scaling of the y axis (temperature value).

- **automatic** Program optimized scaling
- **manual** Here you can define the limits yourself.

Note: The temperature limits are entered via the menu point **Temperature Limits**. This menu point only appears in the graphics menu when **manual** has been selected in the menu **Temperature Scale**.

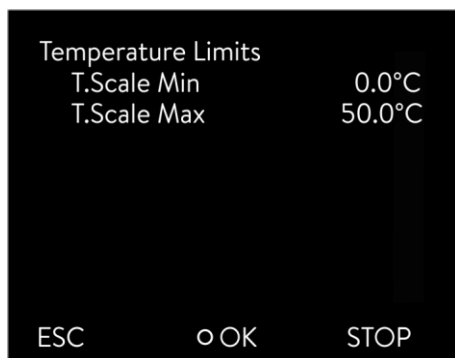

With **Temperature Limits** you can display and manually input the temperature limits for the graphical display.

- **Temp.Scale Min** Displays current minimum value
- **Temp.Scale Max** Displays current maximum value

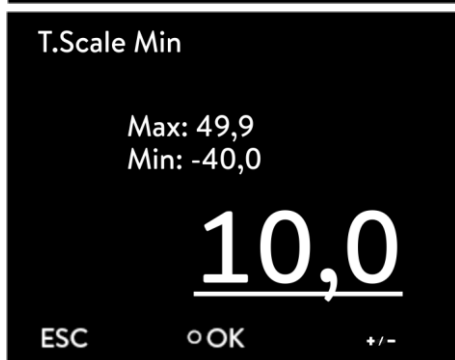

When **Temp.Scale Max** or **Temp.Scale Min** (as in the illustrated example) has been selected, the entry window appears.

The minimum and maximum possible temperature values and the current minimal temperature value are displayed.

- Change the value with or .
- Single figures can be selected by pressing or .
- By pressing (+/-) the arithmetic sign can be changed.
- Confirm your choice with the enter key .

- By pressing (ESC) you are returned to the menu level without any change.

16 External control

The devices can also be optionally controlled via an external Pt100 temperature sensor, which can be connected at the back of the control head. It is necessary to install an external Pt100/LiBus module (⇒ 6.7) for external control (⇒ 18.2). The module is available as an accessory (⇒ 9).



Furthermore, the signal coming from an analogue or serial module can also be controlled. Analogue module and contact modules are available as accessories (⇒ 9).

16.1 Activating external control (external Pt100)



- Access to the main menu level is obtained by pressing the enter key .
- Selection and confirmation of → **Setup** → **Control** → **Contr. Variable**.

The adjacent menu window appears.

- The menu item **extern Pt100** only appears when the module for an external connection is available. A temperature sensor has to be connected to the module
- Select and confirm **extern Pt100** with  or  and .

- By pressing  or  (ESC) you are returned to the menu level without any change.

Note: To show the selected control variable on the display, carry out chapter (⇒ 16.2).

Connection of the external Pt100 to Lemo socket 10S (⇒ 19.5)

16.2 Show the selected control variable (external temperature) on the display



Note: This setup must be done so that the control variable (which was selected in chapter 16.1) is displayed in the basic window.



- Access to the main menu level is obtained by pressing the enter key .
- Selection and confirmation of → **Setup** → **Basic setup** → **Display** → **Displayed T-ext**.

The adjacent menu window appears.

The different menu items only appear when the module is available (e.g. **Temp. ext. Pt100**).

- Select and confirm **Temp. ext. Pt100** with  or  and .

- By pressing  or  (ESC) you are returned to the menu level without any change.

16.3 Setpoint offset operating mode (Diff.set/actual)

It is possible to apply an offset value to the temperature, which is provided by an external temperature sensor and to process it as the set value.

The bath temperature can therefore be operated, for example, -15 °C below the temperature of a reactor measured by the external temperature sensor.

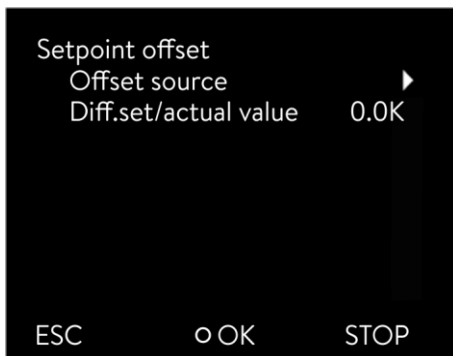



- Access to the main menu level is obtained by pressing the enter key .
- Selection and confirmation of **Setup** → **Control** → **Setpoint offset**.

The adjacent menu window appears.

As well as **Diff.set/actual value** the currently set offset value is displayed.







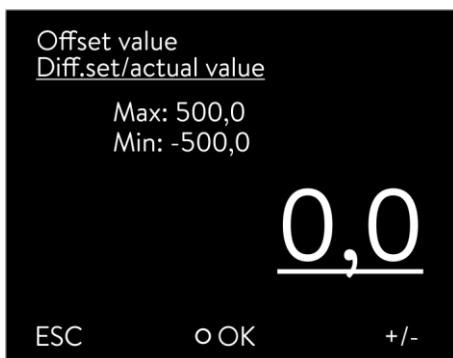

The adjacent menu window appears on selecting the menu point **Offset source**.

- Select and confirm setpoint source with  or  and .
- The setpoint offset is deactivated with "off".



- Select and confirm **Diff.set/actual value** with  or  and .

The adjacent menu window appears. The minimum and maximum possible offset values and the current offset value are displayed.

- Change the value with  or .
- Single figures can be selected by pressing  or .
- By pressing  (+/-) the arithmetic sign can be changed.
- Confirm your choice with the enter key .

- By pressing  (ESC) you are returned to the menu level without any change.

17 Programmer

- The programming function enables you to save five temperature/time programs. The programs consist of a number of temperature/time segments and details about their repetition. The total number of freely program-mable segments is 150. Temperature step changes (time is zero) or also temperature retention phases for the same start and end temperatures in the segment are possible.
On starting the current set value is taken as the starting value of the first segment.
- Changes to the pump level are entered in the relevant line. If the pump level is to remain unchanged, "0" is entered (display shows "---").

17.1 Programming example

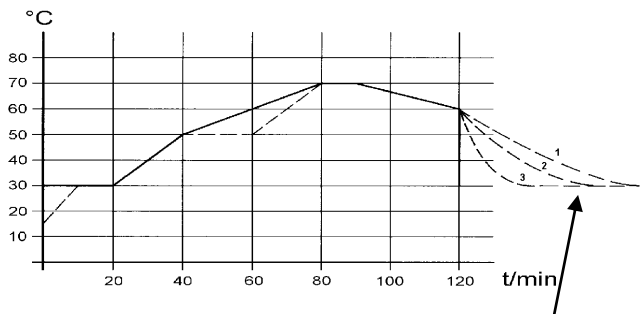

The graph shows as an example the reprogram-ming of a set-point temperature trace.

(Cooling time dependent on device type, consumer, etc.)

Example Seg. No. 2: ➡ "reach 50 °C within 20 minutes"

before (—)									
No.	T _{end}	hh	mm	Tol.		Pump	S1	S2	S3
Start	30.00	--	--	0.1		2	off	off	off
2	50.00	0	20	0.0		2	off	off	off
3	70.00	0	40	0.0		3	off	off	off
4	70.00	0	10	0.1		4	off	off	off
5	60.00	0	30	0.0		2	off	off	off
6	30.00	0	0	0.0		2	off	off	off

The original values ("before" table) are illustrated with a continuous line and the edited trace ("af-ter") table with a broken line.

In the edited table a new segment has been ① entered, and ②, tolerance ③ and pump level ④ have been changed (⇒ 0).

after (- - - , edited)									
No.	T _{end}	hh	mm	Tol.		Pump	S1	S2	S3
Start	30.00	--	--	0.1		2	off	off	off
2	50.00	0	20	0.0		2	off	off	off
3 ①	50.00	0	20	0.1		3	off	off	off
4	70.00	0	20 ②	0.0		4 ④	off	off	off
5	70.00	0	10	0.8 ③		2 ④	off	off	off
6	60.00	0	30	0.3		2	off	off	off
7	30.00	0	0	0.0		2	off	off	off

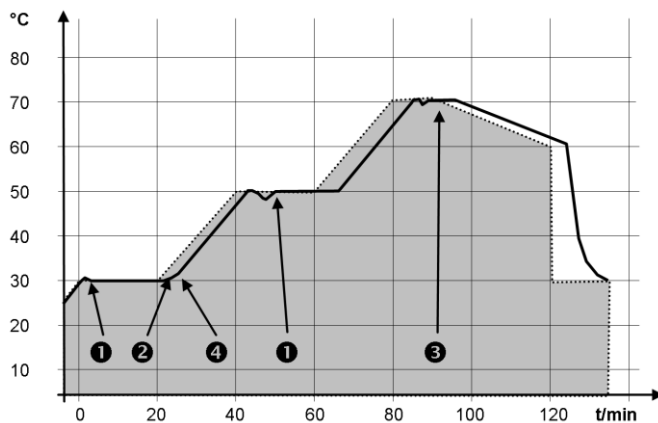

The tolerance entry can have a large effect with external bath control. The adjacent graph of the edited trace shows the possible run-on of the actual temperature in the bath vessel (continuous line) for the set-point temperature of the programmer (highlighted in gray).

Note:

- The tolerance field facilitates exact conformance to the dwell time at a specified temperature. The following segment is only processed when the actual temperature reaches the tolerance band ❶, so that for example the ramp of segment 2 is only started delayed by ❷.
- A tolerance range which is too tight can however also cause undesired delays. **In particular with external control** the range should not be chosen too tightly. In Segment 5 a larger tolerance has been entered, so that the desired time of ten minutes is maintained even with settling action ❸.
- Only flat (slow) ramps should be programmed where necessary with a tolerance range. Steep ramps which lie close to the maximum possible heating or cooling rates of the thermostat may be severely delayed by a tolerance range that is too tight (here in Segment 2) ❹.

Note: No time specification is possible in the start segment (No. 1). The temperature of the first segment is attained as quickly as possible in order to switch to segment 2 after reaching the set tolerance.

17.2 Creating and editing a program

In the following functions are explained below:

- Creating and editing a program.
- Insert or append a new segment.
- Delete a segment.

Note:

- New segments can be inserted and existing ones changed, also the currently active segment, even when a program is currently being executed. Furthermore, except for the currently active segment, all segments can be deleted at any time.
- Changes to the currently running segment are possible. The segment is continued as though the change has been valid since the start of the segment.
- If the new segment time is shorter than the already expired segment time, then the program skips to the next segment.
- If a segment time is required > 999h: 59min, then this time must be spread over several consecutive segments.

Creating and editing a program:

Compare the programming example (⇒ 17.1)





- Access to the menu level is obtained by pressing .
- The adjacent menu window appears by selecting and confirming **Programmer**.

No.	Tend	hh	mm	Tolerance
Start	30.00	--	--	0.1
1	50.00	0	20	0.0
2	50.00	0	20	0.0
3	70.00	0	20	0.1
4	60.00	0	30	0.0
5	30.00	0	0	0.0

ESC OK DELETE

- By selecting and confirming **Program 1** → **Edit** you obtain access to the editor view of the programmer. To view the complete window information go to the right with .

- With the keys , ,  and  you obtain access to the individual segments.

- The appropriate parameter is selected with  and can be changed with  and .



- Single figures can be selected by pressing  or .

No.	Pump	S1	S2	S3
Start	2	off	---	off
1	2	off	---	off
2	3	off	---	off
3	4	off	---	off
4	2	off	---	off
5	2	off	---	off

ESC OK ---

- Confirm your choice with the enter key .

- You can now select the next segment to be changed using the control keys.

- You can quit the edit window at any time without changes using  (ESC). When the cursor is located on a segment number, using  you return to the menu level of the programmer without changes.

Note: No time specification is possible in the start segment. The temperature of the first segment is attained as quickly as possible in order to switch to segment 2 after reaching the set tolerance.

The programmer edit window contains the following parameters:

No.: Program segment number

Tend: Final temperature to be attained

hh: Time in hours (hh) in which the specified temperature is to be attained

mm: Time in minutes (mm) in which the specified temperature is to be attained

If the value "0" is entered in the fields "hh" and "mm", the set value is accepted immediately and the bath temperature approached as quickly as possible.

Tolerance: Defines how exactly the final temperature is to be attained before the next segment it processed.

If the tolerance range is selected too small in the "Tolerance" field, the program might not continue, because the required tolerance is not achieved.

Pump: Pump level at which the segment is to be processed.



S1, S2, S3: Switching contacts of the contact module (if present) can be programmed here.

Contact modules are available as accessories (⇒ 9). The setting "-" stands for no change to the preceding segment, i.e. if "-" is present in all fields, the contact setting of the start setup or that before the program start is retained.

Inserting a new segment

No.	Tend	hh	mm	Tolerance
Start	30.00	--	--	0.1
1	50.00	0	20	0.0
2	50.00	0	20	0.0
3	70.00	0	20	0.1
4	60.00	0	30	0.0
5	30.00	0	0	0.0



ESC ◯ NEW DELETE

- With  or  go to the segment number under which the new segment is to be inserted.
- A new segment is inserted on pressing  (NEW). You can edit it as described above.

Deleting a segment

No.	Tend	hh	mm	Tolerance
Start	30.00	--	--	0.1
1	50.00	0	20	0.0
2	50.00	0	20	0.0
3	70.00	0	20	0.1
4	60.00	0	30	0.0

ESC ◯ NEW DELETE

- With  or  choose the segment to be deleted.
- The new segment is removed on pressing  (DELETE).

17.3 Starting the program

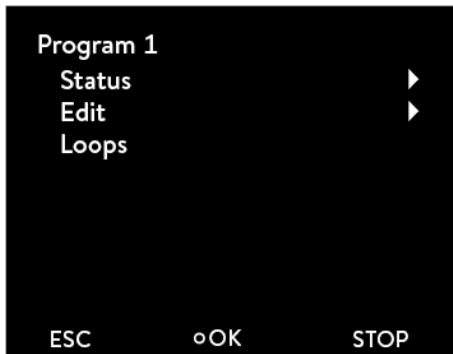

- The submenu **Status** appears by selecting and confirming → **Programmer** → **Program 1**.
- With the menu **Status** you can carry out the following with the commands

Start	Start program
Hold	Hold program
Continue	Continue program
Stop	Terminate program

by pressing the enter key .



- You can also pause the programmer with  (STOP). When "Standby" is deactivated, the programmer continues running.

Instructions which cannot be executed due to the situation are not displayed. **Continue** therefore only appears if **Hold** has been activated.

17.4 Interrupting, continuing or terminating the program



After the program start the menu points **Hold** and **Stop** are displayed.

- The options can be selected with  or .



Hold	Interrupt program
Stop	Terminate program

- Confirm your choice with the enter key .



To continue a program held by **Hold**

- Select the option **Continue** with  or .
- Confirm your choice with the enter key .

- Also  (Standby) holds the programmer. Pump, heating and chiller are switched off.
- When  (Standby) is pressed again, the programmer returns to the previously selected operating mode (Hold or active operation):

17.5 Defining the number of program loops (Loops)



Programs can be processed many times.

- The submenu **Loops** appears by selecting and confirming → **Programmer** → **Program n.**
- Select and confirm **Loops** with ▲ or ▼ and ○.



- Enter the desired number with ▲ or ▼.
- Confirm your choice with the enter key ○.

Note: To enter two or three-figure numbers move the cursor ◀▶ to the appropriate point and change the figures with ▲ or ▼.

If "0" is entered, the program is continuously repeated.

- By pressing **ESC** (ESC) you are returned to the menu level without any change.

18 Control parameters

The control parameters have been optimized at the factory for operation as a bath thermostat (with water as the heat transfer liquid) with internal control. The standard parameters are already set as default also for the thermostatic control of external applications with external control.

Depending on the application, the configuration can be adapted from case to case as required. Also the thermal capacity and the viscosity of the heat transfer liquid affect the control behavior.

Note: Only change the control parameters if you have adequate knowledge of control techniques.

18.1 Internal control variable (internal temperature sensor)

If you have not connected any temperature sensor, read further here. For activated external control read (⇒ 18.2).

The control corresponds to the set-point temperature with the current bath temperature and calculates the set value for heating or cooling.

These control parameters can be set:

Description	Short form	Unit
Proportional range	X_p	K
Reset time	T_n	s
Derivative time	T_v	s
Damping time	T_d	s

If " T_v manual/auto" is set to "auto" (automatic), T_v and T_d cannot be changed. They are in this case derived from T_n with fixed factors.

Consider the effect of the temperature limits T_{ih} and T_{il} (⇒ 7.4.5) on the control.



- Access to the main menu level is obtained by pressing the enter key .

- Selection and confirmation of  Setup  Control 
Control parameter  Intern Pt100.

The adjacent menu window appears. Apart from the control parameters the currently set values are displayed.

- Under the menu point "Tv manual/auto" you can select between manual and automatic entry using .

The selection "automatic" is displayed in the menu line by (auto). If "automatic" is selected, the entry is blocked for the parameters Tv and Td.

- Select and confirm parameters with  or  and .

The appropriate edit window appears with Min and Max figures for the parameter values Xp, Tn, Tv and Td.

- Change the value with  or .

- Single figures can be selected by pressing  or .

- Confirm your choice with the enter key .

- By pressing  (ESC) you are returned to the menu level without any change.

18.2 External control variable

The setting options illustrated in this section are only possible with a connected external temperature sensor or with an existing module (as activated as control variable in Section 16.1) for reading in the actual temperature.

The control system for external actual values is realized as a two-stage cascade controller to improve the response to setpoint changes. From the temperature setpoint and the external temperature, which is generally measured by the external Pt100, a "master controller" determines the "internal setpoint" which is passed to the slave controller. Its set value controls the heating and cooling.

Correcting quantity limit

If a step change in set-point temperature is specified, the optimum control might set an outflow temperature which is substantially higher than the temperature desired on the external vessel. With the correction limitation the maximum permissible deviation between the temperature in the external consumer and the temperature of the outflow liquid can be limited. The limit can be set via a menu point (⇒ F.2.1).

These parameters can be set on the master controller (PIDT or external controller):

Description	Short form	Unit
Gain	K_{pe}	-
Proportional range	Prop_E	K
Reset time	T_{ne}	s
Derivative time	T_{ve}	s
Damping time	T_{de}	s

These parameters can be set on the slave controller (P-controller):

Description	Short form	Unit
Proportional range	X_{pf}	K

If "Tv manual/auto" is set to "automatic", T_{ve}, T_{de} and Prop_E cannot be changed. T_{ve} and T_{de} are in this case derived from T_{ne} with fixed factors.





- Access to the main menu level is obtained by pressing the enter key .

- Selection and confirmation of    .

The adjacent menu window appears. Apart from the control parameters the currently set values are displayed.

- Under the menu point "Tv manual/auto" you can select between manual and automatic entry using .

The selection "automatic" is displayed in the menu line by (auto). If "automatic" is selected, the entry is blocked for the parameters Tv and Td.

- Select and confirm parameters with  or  and .

The respective edit window appears with Min and Max figures for the parameter values Kpe, Tne, Tve, Tde and Xpf.

- Change the value with  or .

- Single figures can be selected by pressing  or .



- Confirm your choice with the enter key .

- By pressing  (ESC) you are returned to the menu level without any change.

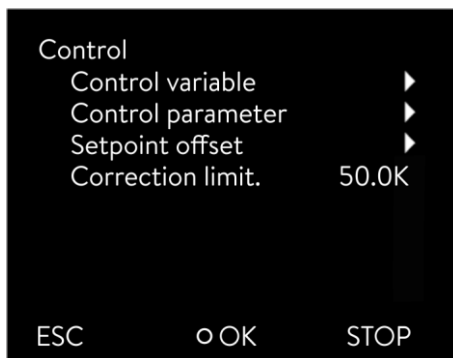
18.2.1 Setting the correcting quantity limit



- Access to the main menu level is obtained by pressing the enter key .

- Selection and confirmation of  .

The adjacent menu window appears.

- Select and confirm  with  or  and .

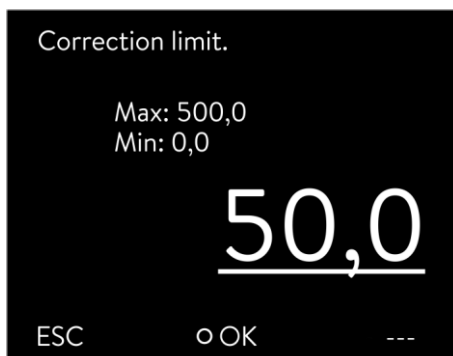

The adjacent menu window appears. The minimum and maximum possible values and the current value are displayed.

- Change the value with  or .

- Single figures can be selected by pressing  or .

- Confirm your choice with the enter key .

- By pressing  (ESC) you are returned to the menu level without any change.

18.2.2 Procedure for setting the control parameters for external control

1. Activating external control (⇒ 16.1).
2. Set the slave controller:
 - 2.1. Parameter to **auto**;
Xpf in dependence of:
 - Check or adjust device type (⇒ 8.2.4).
 - Select heat transfer liquid with as low-viscosity and with as high a thermal capacity as possible.
Ranking list: Water, water/glycol, oils, Fluorinert®.
 - Set pump level as high as possible,
 - Make sure there is adequate circulation,
 - select the hose length as short as possible, e.g. 2 x 1 m,
 - select the hose cross-sectional area as large as possible, e.g. ½ inch,
 - set the throughput through the external consumer as large as possible.
 - 2.2. Set Xpf:
 - With a tendency to oscillate with a short period of oscillation (e.g. 30 s) → Xpf smaller, otherwise larger,
 - with poor thermal coupling and a large mass to temper → large (e.g. 2 – 5, possibly even larger),
 - with good thermal coupling and a small mass to temper → small (e.g. 0.2 – 0.7),
 - if fast temperature changes are required, external baths should be controlled if possible with internal control. Otherwise choose Xpf to be very small (0.05 – 0.1).
3. Setting the master controller (PID controller):
 - First start with Auto, then possibly continue with manual.
 - 3.1. Setting Kpe:
 - With a tendency to oscillate (long period of oscillation, e.g. 10 min) → Kpe larger, otherwise smaller,
 - 3.2. Setting Tne/ Tve/ Tde:
 - Generally quite high values (Tne = 70 s – 200 s; Tve = 50 s – 150 s),
 - with smaller values → faster transient responses, otherwise slower transient responses and therefore less oscillation,
 - Tve: To reduce transients → increase Tve, otherwise vice versa,
 - Tde (damping for Tve): generally approx. 10 % of Tve.
4. Correcting quantity limit (⇒ 18.2.1) and temperature limits (Til/Tih) (⇒ 7.4.5).
 - Set according to the physical boundary conditions.

Example:

Heat transfer liquid	Correcting quantity limit	Til	Tih
Water	depends on heat transfer liquid and vessel	5 °C	95 °C

19 Interface modules

19.1 Menu structure of the modules

From this overview all menu points which cannot be executed in practice are masked out.

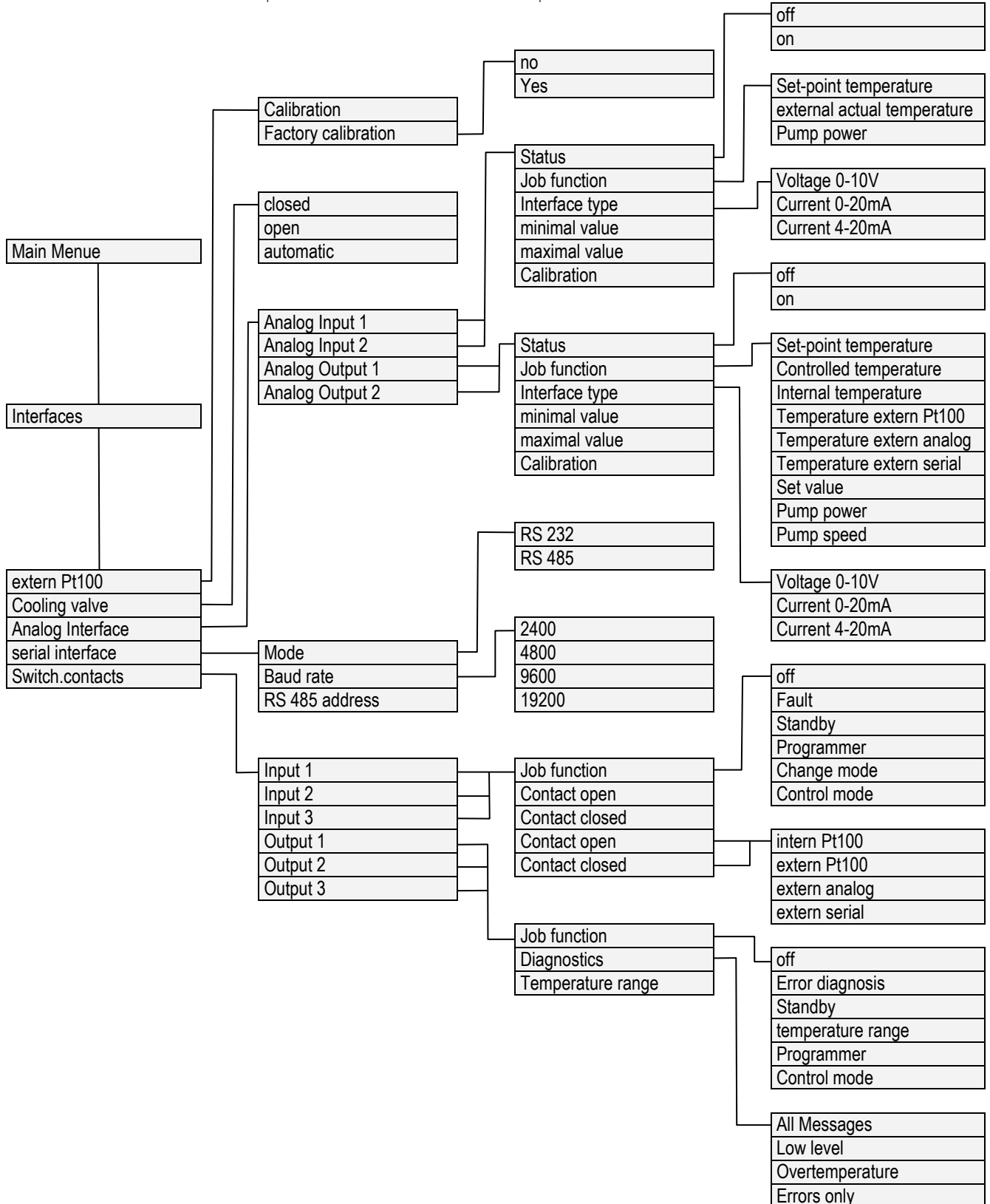

19.2 Analog module

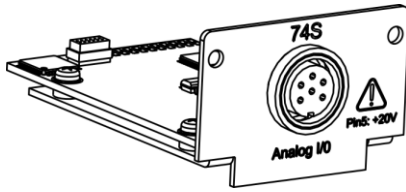

Analogue Module (LAUDA catalogue no. LRZ 912) has two inputs and two outputs, which are brought out to a six-pole DIN socket to Namur Recommendation (NE28).

The inputs and outputs can be set independently of one another as a 0 – 20 mA, 4 – 20 mA or 0 – 10 V interface. Various functions can be selected for the inputs and outputs. Accordingly, the signal on the input is interpreted differently and different information appears on the output.

In addition the interfaces can be freely scaled according to the set function. 20 V DC is available for measurement transducers.

The following values can be defined via the inputs:

- **Set-point temperature** Setpoint temperature
- **Ext. Actual temperature** External actual temperature
- **Pump power** Pump power

The following values can be output via the outputs:

- **Set-point temperature** Set-point temperature
- **Controlled temp.** The temperature to which the system is being controlled.
- **Internal temp.** Actual temperature (bath temperature)
- **Temp.extern Pt100** External actual temperature of Pt100
- **Temp.extern analog** External actual temperature of the analogue input
- **Temp.extern serial** External actual temperature of the serial interface:
- **Set value** Set value
- **Pump power** Pump power
- **Pump speed** Pump speed

In addition the interfaces can be freely scaled according to the set function with **minimal value** and **maximal value**.

For example: 4 mA corresponds to 0 °C and 20 mA corresponds to 100 °C.

Accuracy of the inputs and outputs after calibration better than 0.1 % of full scale.

- Inputs, current
- Inputs, voltage
- Outputs, current
- Outputs, voltage
- Input resistance < 100 Ohm
- Input resistance > 50 kOhm
- Burden < 400 Ohm
- Load > 10 kOhm

Connection of analogue inputs and outputs

A six-pole round connector with screw lock and contact assignment according to DIN EN 60130-9 or IEC 130-9 are required.

A suitable coupling plug is obtainable under the catalogue no. EQS 057.

View of socket (front) or solder side of plug:

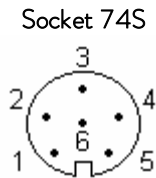

Contact 1	Output 1
Contact 2	Output 2
Contact 3	0 V reference potential
Contact 4	Input 1
Contact 5	+20 V (max. 0.1 A)
Contact 6	Input 2

Note: Only use screened connecting leads and connect the screen to the plug housing.

19.3 RS 232/485 interface module

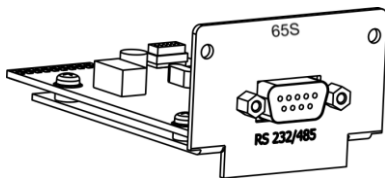

RS 232/485 Interface Module (LAUDA catalogue no. LRZ 913) with nine-pole SUB-D socket. Electrically isolated using optocouplers. With the LAUDA instruction set, extensively compatible to Ecoline, Proline and Integral series.

The RS 232 interface can be connected directly to the PC with a 1:1 connected cable (catalogue no. EKS 037, 2 m cable and EKS 057, 5 m cable).

19.3.1 Connecting lead and interface test RS 232

Signal	Computer				Thermostat		Signal
	9-pole Sub-D socket		25-pole Sub-D socket		9-pole Sub-D socket		
	①	②	①	②	①	②	
R x D	2	2	3	3	2	2	T x D
T x D	3	3	2	2	3	3	R x D
DTR	4		20		4		DSR
Signal Ground	5	5	7	7	5	5	Signal Ground
DSR	6		6		6		DTR
RTS	7		4		7		CTS
CTS	8		5		8		RTS

① with hardware handshake: On connecting a thermostat to the PC use a 1:1 and **not a** null-modem cable.

② without hardware handshake: Set the operating mode on the PC "without hardware handshake".

- Use screened leads and connect screen to plug case.
- The wires are electrically isolated from the rest of the electronics.
- Non-assigned pins should not be connected.

The RS 232 interface can be checked in a simple way with a connected PC running Microsoft Windows operating system. With Windows® 95/98/NT/XP using the program "HyperTerminal".

“HyperTerminal” is no longer part of the operating system in Windows Vista, Windows 7, Windows 8 and Windows 10.

- With the LAUDA software “Wintherm Plus” (catalogue number LDSM2002) the RS 232 interface can be addressed.
- In the Internet there are terminal programs available as freeware. These programs offer similar functions as “HyperTerminal” (for example PuTTY). Search for “serial port terminal program”.

19.3.2 RS 232 protocol

Note the following aspects:

- The interface operates with one stop bit, no parity bit and with eight data bits.
- Transfer speed alternatively: 2400, 4800, 9600 (factor setting) or 19200 baud.
- The RS 232 interface can be operated with or without hardware-handshake (RTS/CTS).
- The command from the computer must be terminated with a CR, CRLF or LFCR.
- The response from the thermostat is always terminated with a CRLF.
- After each command sent to the thermostat, it is necessary to wait for the reply before sending another command. This ensures that the sequencing of inquiries and answers is clear.

CR = Carriage Return (Hex: 0D); LF = Line Feed (Hex: 0A)

Example: Set-value transfer of 30.5 °C to the thermostat

Computer	Thermostat
„OUT_SP_00_30.5“CRLF	➔
➔	„OK“CRLF

19.3.3 RS 485 connecting lead

Thermostat	
9-pole Sub-D socket	
Contact	Data
1	Data A (-)
5	SG (Signal Ground) optional
6	Data B (+)

- Use screened connecting leads. Connect screen to the plug housing.
- The wires are electrically isolated from the rest of the electronics.
- Non-assigned pins should not be connected.

An RS 485 bus requires essentially a bus termination in the form of a terminating network, which provides a defined idle state in the high impedance phases of bus operation. The bus termination is as follows:

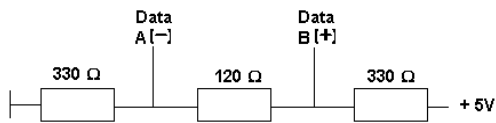

Generally, this terminating network is integrated on the PC plug-in card (RS 485).

19.3.4 RS 485 protocol

Note the following aspects:

- The interface operates with one stop bit, no parity bit and with eight data bits.
- Transfer speed alternatively: 2400, 4800, 9600 (factor setting) or 19200 baud.
- The device address always precedes the RS 485 commands. Up to 127 addresses are possible. The address must always consist of three figures (A000_... to A127_...).
- The command from the computer must be terminated with a CR.
- The response from the thermostat is always terminated with a CR.

CR = Carriage Return (Hex: 0D)

Example: Set-value transfer of 30.5 °C to the thermostat with address 15.

Computer	Thermostat
„A015_OUT_SP_00_30.5“CR	➔
➔	„A015_OK“CR

19.4 LiBus module



LiBus module (catalogue number LRZ 920) has a socket (70S) for connecting components via the LAUDA device bus LiBus (Command remote control, shut down/reverse flow protection, cooling water valve).

LiBus = LAUDA internal device BUS (CAN-based)

For extension cord for LiBus, see accessories (⇒ 9)

19.5 Pt100/LiBus module

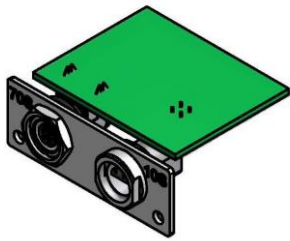

The Pt100/LiBus module (catalogue no. LRZ 918) has two connection sockets.

A Lemo socket (10S) to connect an external Pt100 temperature probe and a socket (70S) for connection of components via the LAUDA device bus LiBus (Command remote control, shut down/reverse flow protection, cooling water valve).

Plug: 4-pin Namur standard (Lemo) for Pt100 connection, catalogue number EQS 022.

External Pt100 (10S)

Lemo socket 10S
contact

1	+	I
2	+	U
3	-	U
4	-	I

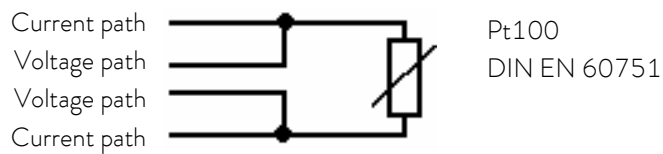

Contact assignment

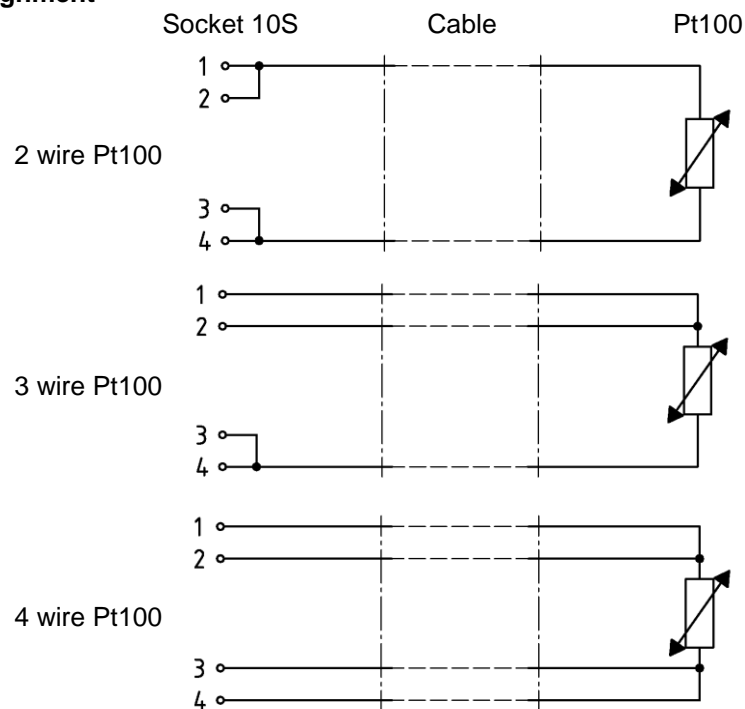

Please note:

- Use protected connection lines. Connect the protective screen with the connector shell.

19.6 USB interface

Important: First install the driver and then connect the thermostat to the PC.

19.6.1 Description

The ECO heating and cooling thermostats are equipped with a USB interface at the back of the control head. This enables the connection of a PC and operation with the thermostat control software Wintherm Plus. In addition software updates are possible via the USB interface.

The connecting lead is not included in the items supplied. When connecting up, make sure the correct plug is used.

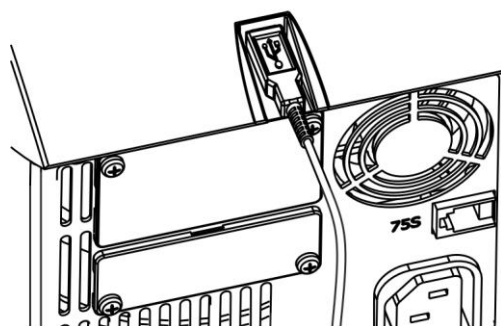

USB interface

LAUDA makes the drivers specially produced for the USB interface available free of charge for download at <http://www.lauda.de>.

19.6.2 Installation of the USB driver

The driver is installed once per PC.

Supported operating systems: Windows ME, Windows XP, Windows 2000, Windows VISTA, Windows 7, Windows 8 and Windows 10.

Execute the file "LAUDA_ECO_USB_Driver.exe". The window below opens.

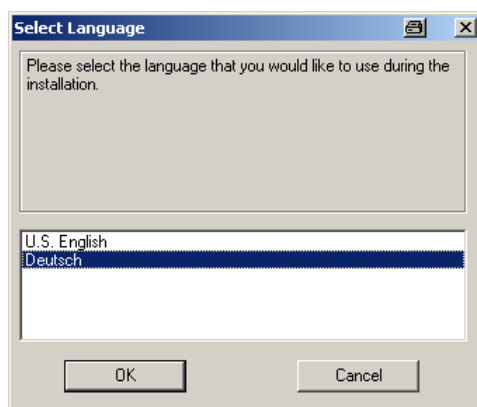

1. Select the language and confirm with .

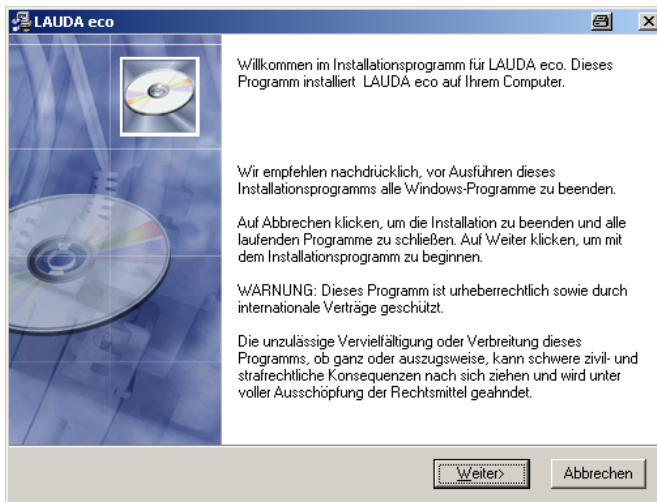

2. Key **Continue**

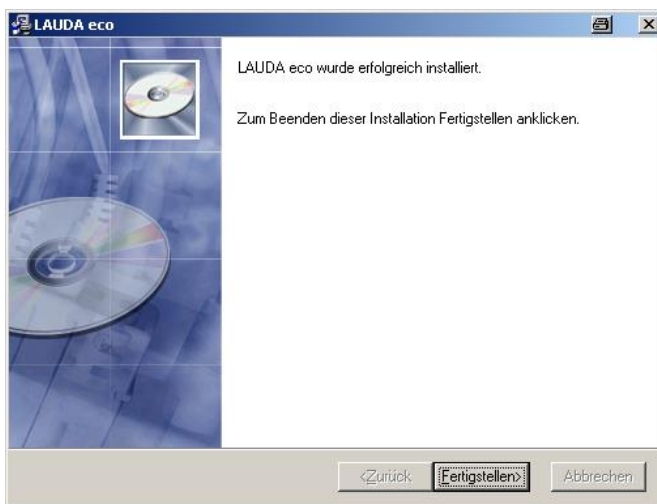

3. Key **Finish**

Driver installation is installed

19.6.3 Connecting the thermostat to the PC

If an ECO thermostat is connected via the USB interface, it is automatically assigned to a free COM port. The PC unambiguously identifies the thermostat via a serial number internal to the thermostat and always assigns the same COM port to this thermostat.

If further ECO thermostats are connected via the USB interface, these thermostats are assigned other free COM ports.

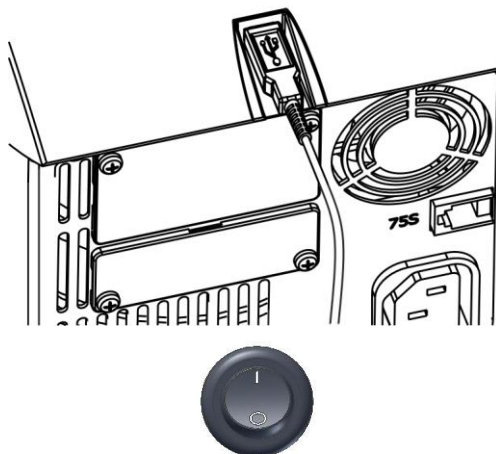

1. Plug the USB cable into the control head.

2. Switch on the thermostat at the mains switch.

For the first time, after installation on the PC, a wizard opens to search for new hardware. Please follow the wizard instructions.

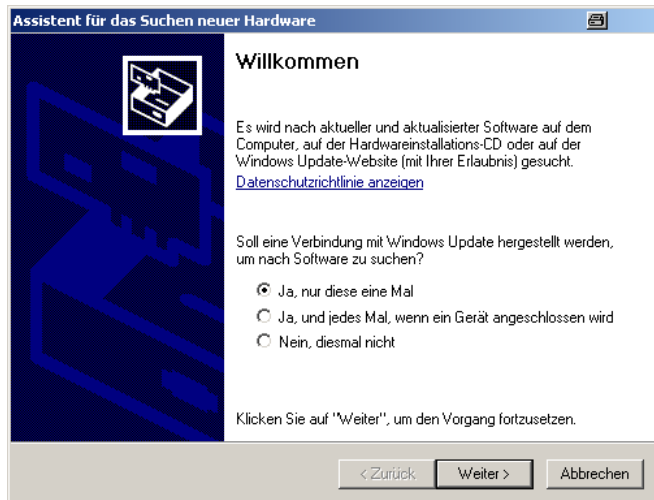

3. Key

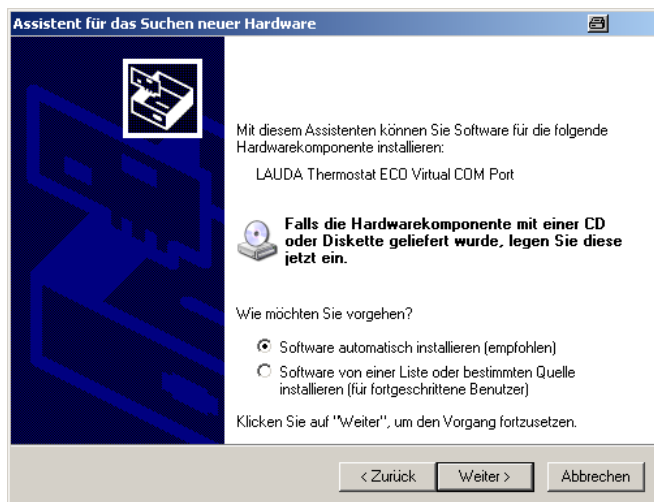

4. Key

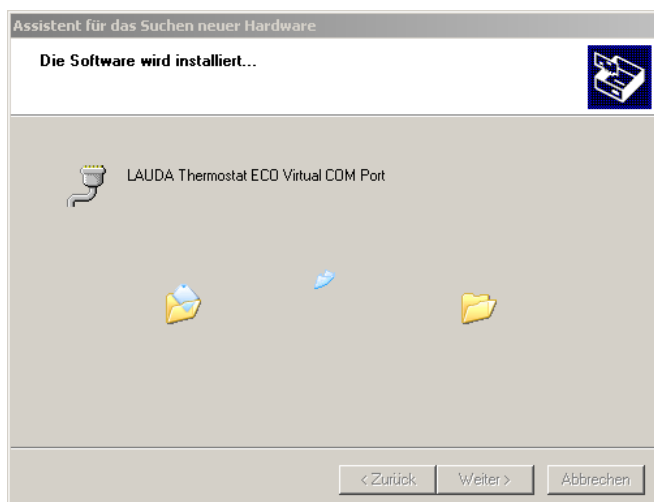

This window is covered by the following window "Hardware installation" (see below);



5. Click on .

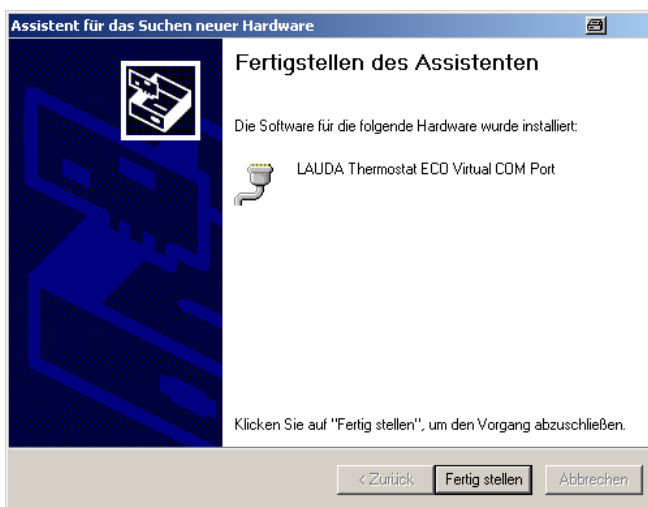

6. Click on the key .

19.6.4 Where is the ECO Virtual COM Port?

The thermostat can be operated via conventional communication programs (e.g. HyperTerminal) as a COM port. Further settings, such as baud rate, are not needed.

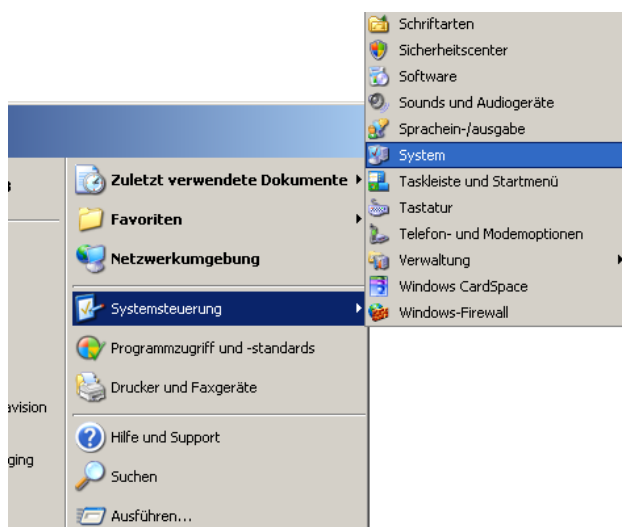

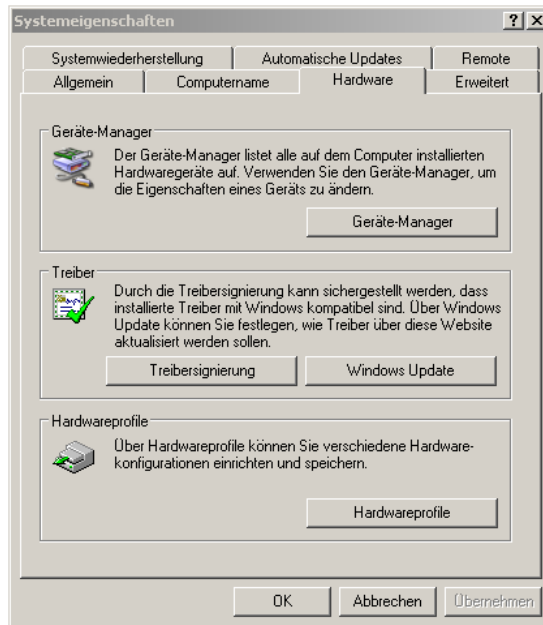

Click on the tab with the mouse and then on the Device manager.

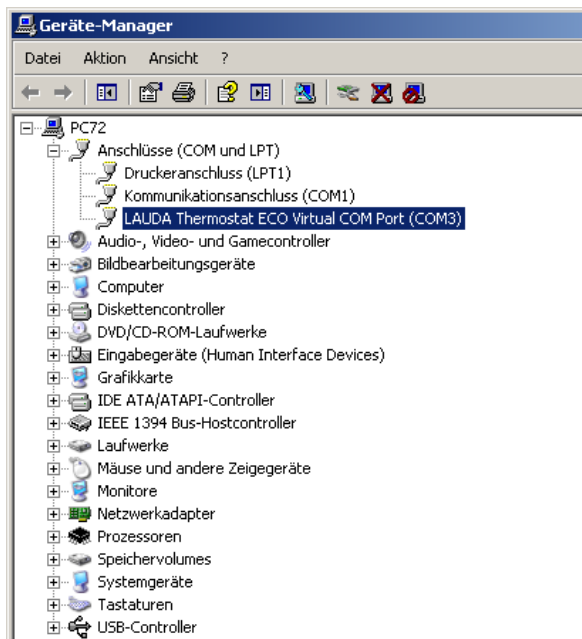

19.7 Commands and error messages applicable to the RS 232/485 interface module and to the Ethernet interface

19.7.1 Interface write commands (data issued to the thermostat)

Command	Meaning
OUT_PV_05_XXX.XX	Specify external temperature via interface
OUT_SP_00_XXX.XX	Set-value transfer with max. 3 places before the decimal point and max. 2 places after it.
OUT_SP_01_XXX	Pump power level 1 to 6
OUT_SP_02_XXX	Cooling operating mode (0 = OFF / 1 = ON / 2 = AUTOMATIC).
OUT_SP_04_XXX	TiH outflow temperature limit, upper value
OUT_SP_05_XXX	TiL outflow temperature limit, lower value

OUT_PAR_00_XXX.X	Setting of the control parameter Xp.
OUT_PAR_01_XXX	Setting of the control parameter Tn (5 – 180 s; 181 = Off).
OUT_PAR_02_XXX	Setting of the control parameter Tv.
OUT_PAR_03_XX.X	Setting of the control parameter Td.
OUT_PAR_04_XX.XX	Setting of the control parameter KpE.
OUT_PAR_05_XXXX	Setting of the control parameter TnE (0 – 9000 s; 9001 = Off).
OUT_PAR_06_XXXX	Setting of the control parameter TvE (5 = OFF).
OUT_PAR_07_XXXX.X	Setting of the control parameter TdE
OUT_PAR_09_XXX.X	Setting the correcting quantity limit.
OUT_PAR_10_XX.X	Setting of the control parameter XpF.
OUT_PAR_14_XXX.X	Setting of the setpoint offset.
OUT_PAR_15_XXX	Setting of the control parameter PropE.

OUT_MODE_00_X	Keypad: 0 = released / 1 = locked (corresponds to: "KEY").
OUT_MODE_01_X	Control: 0 = int. / 1 = ext. Pt100 / 2 = ext. Analog / 3 = ext. Serial.
OUT_MODE_03_X	Keypad Command remote control: 0 = released / 1 = locked.
OUT_MODE_04_X	Setpoint offset source: 0=normal / 1=ext. Pt / 2=ext. analog / 3=ext. serial.
START	Switches the device on (from Standby)
STOP	Switches the device in Standby (pump, heating, chiller off).

RMP_SELECT_X	Selection of program (1 – 5) to which further commands are to refer. When the device is switched on Program 5 is selected.
RMP_START	Start the programmer.
RMP_PAUSE	Stop the programmer.
RMP_CONT	Start the programmer again after a hold.
RMP_STOP	Terminate the program.
RMP_RESET	Delete program (all segments)

RMP_OUT_00_XXX.XX_XXXXX_XXX.XX_X	Sets programmer segment (temperature, time, tolerance, and pump level). A segment is appended and assigned appropriate values.
RMP_OUT_02_XXX	Number of program loops: 0 = endless / 1 – 250.

Note:

- For " " (space character) is also admissible.
- Response from thermostat "OK" or with an error "ERR_X" (RS 485 interface e.g. "A015_OK" or with an error "A015_ERR_X".)
- The command from the computer must be terminated with a CR, CRLF or LFCR.
- The response from the thermostat is always terminated with a CRLF.
- After each command sent to the thermostat, it is necessary to wait for the reply before sending another command. This ensures that the sequencing of inquiries and answers is clear.

CR = Carriage Return (Hex: 0D); LF = Line Feed (Hex: 0A)

Admissible data formats:

-XXXX.XX	-XXXX.X	-XXXX.	-XXXX	XXXX.XX	XXXX.X	XXXX.	XXXX
-XXX.XX	-XXX.X	-XXX.	-XXX	XXX.XX	XXX.X	XXX.	XXX
-XX.XX	-XX.X	-XX.	-XX	XX.XX	XX.X	XX.	XX
-X.XX	-X.X	-X.	-X	X.XX	X.X	X.	X
-.XX	-.X	.XX	.X				

19.7.2 Interface read commands

Command	Meaning
IN_PV_00	Query of the bath temperature (outflow temperature)
IN_PV_01	Query of the controlled temperature (int./ext., Pt/ext., Analog/ ext. serial).
IN_PV_03	Query the external temperature TE (Pt100).
IN_PV_04	Query the external temperature TE (Analog Input).
IN_PV_10	Query of the bath temperature in 0.001 °C.
IN_PV_13	Query the external temperature TE (Pt100) in 0.0001 °C.

IN_SP_00	Query of the temperature set value.
IN_SP_01	Query of the pump power level.
IN_SP_02	Query of cooling mode (0 = OFF / 1 = ON / 2 = AUTOMATIC).
IN_SP_03	Query of the overtemperature switch-off point.
IN_SP_04	Query of the outflow temperature limit TiH.
IN_SP_05	Query of the outflow temperature limit TiL.

IN_PAR_00	Query of the control parameter Xp.
-----------	------------------------------------

Command	Meaning
IN_PAR_01	Query of the control parameter Tn (181 = OFF).
IN_PAR_02	Query of the control parameter Tv.
IN_PAR_03	Query of the control parameter Td.
IN_PAR_04	Query of the control parameter KpE.
IN_PAR_05	Query of the control parameter TnE (response: XXXX; 9001 = OFF).
IN_PAR_06	Query of the control parameter TvE (response: XXXX; 5 = OFF).
IN_PAR_07	Query of the control parameter TdE (response: XXXX.X).
IN_PAR_09	Query of the max. correcting quantity limit.
IN_PAR_10	Query of the control parameter XpF.
IN_PAR_14	Query of setpoint offset.
IN_PAR_15	Query of the control parameter PropE.

IN_DI_01	Status of Contact Input 1: 0 = open/ 1 = closed.
IN_DI_02	Status of Contact Input 2: 0 = open/ 1 = closed.
IN_DI_03	Status of Contact Input 3: 0 = open/ 1 = closed.
IN_DO_01	Status of Contact Output 1: 0 = NO contact open/ 1 = NO contact closed.
IN_DO_02	Status of Contact Output 2: 0 = NO contact open/ 1 = NO contact closed.
IN_DO_03	Status of Contact Output 3: 0 = NO contact open/ 1 = NO contact closed.

IN_MODE_00	Keypad: 0 = released / 1 = locked.
IN_MODE_01	Control: 0 = int./ 1 = ext. Pt100 / 2 = ext. Analog / 3 = ext. Serial.
IN_MODE_02	Standby operation: 0 = Device ON / 1 = Device OFF.
IN_MODE_03	Keypad remote control unit Command: 0 = released / 1 = locked.
IN_MODE_04	Setpoint offset source: 0 = normal/ 1 = ext. Pt/ 2 = ext. Analog/ 3 = ext. Serial.

TYPE	Query of the device type (response = "ECO")
VERSION_R	Query of the software version number of the control system.
VERSION_S	Query of the software version number of the protection system.
VERSION_B	Query of the software version number of the Command remote control.
VERSION_T	Query of the software version number of the cooling system.
VERSION_A	Query of the software version number of the analogue module.
VERSION_V	Query of the software version number of the RS 232/485 module.
VERSION_Y	Query of the software version number of the Ethernet-Modul
VERSION_Z	Query of the software version number of the EtherCAT-Modul
VERSION_D	Query of the software version number of the digital module.
VERSION_M_0	Query of the software version number of the solenoid valve (cooling water).

Command	Meaning
VERSION_M_3	Query of the software version number of the solenoid valve (shut-off valve 1).
VERSION_M_4	Query of the software version number of the solenoid valve (shut-off valve 2).
VERSION_M_5	Query of the software version number of the high temperature cooler.
VERSION_E	Query of the software version number of the external Pt100 module.
STATUS	Query of the device status 0 = OK, -1 = Error.
STAT	Query of error diagnosis response: XXXXXXXX → X = 0 no error, X = 1 error 1st character = Error 2nd character = Alarm 3rd character = Warning 4th character = Overtemperature 5th character = Low Level 6th character = 0 7th character = External control value missing

RMP_IN_00_XXX	Query of a program segment XXX (Response: e.g. 030.00_00010_005.00_001.00 => Set-point temperature = 30.00 °C, Time = 10 min, Tolerance = 5,00 K, Pump stage = 1).
RMP_IN_01	Query of the current segment number.
RMP_IN_02	Query of the set program loops.
RMP_IN_03	Query of the current program loops.
RMP_IN_04	Query of to which program further commands refer.
RMP_IN_05	Query of which program is currently running (0 = none).

LOG_IN_00_XXXX	Query of a measurement point XXX from data logger (Response: e.g. 020.00_021.23_030.50 => Set-point temperature = 20.00 °C bath temperature = 21.23 °C, external temperature = 30.5 °C).
LOG_IN_01	Query of all measurement points from data logger In contrast to the command "LOG_IN_00" a tabulator character is used here as delimiter instead of '!'. The measurement points are separated by CR and LF. The end is signaled by CR LF CR LF.
LOG_IN_02	Query of starting time of data logger (Response: e.g. 20_14_12_20 => Day 20, 14:12:20 hrs.).
LOG_IN_03	Query of acquisition interval from data logger (Response in seconds).

Note:

- For " " (space character) is also admissible.
- Unless otherwise stated, with the command the response is always in the fixed-point format "XXX.XX" or for negative values "-XXX.XX" or "ERR_X" (RS 485 interface, e.g. "A015_XXX.XX" or "A015_ERR_X").
- The command from the computer must be terminated with a CR, CRLF or LFCR.
- The response from the thermostat is always terminated with a CRLF.
- After each command sent to the thermostat, it is necessary to wait for the reply before sending another command. This ensures that the sequencing of inquiries and answers is clear.

CR = Carriage Return (Hex: 0D); LF = Line Feed (Hex: 0A)

19.7.3 Interface error messages

Error	Meaning
ERR_2	Incorrect entry (e.g. buffer overflow)
ERR_3	Wrong command.
ERR_5	Syntax error in the value.
ERR_6	Impermissible value.
ERR_8	Module or value not present.
ERR_30	Programmer, all segments occupied.
ERR_31	No set-point input possible.
ERR_33	External probe missing.
ERR_34	Analog value not present.

19.7.4 Driver software for LABVIEW®

With the aid of the program development tool LABVIEW® from National Instruments (<http://sine.ni.com/apps/we/nioc.vp?cid=1381&lang=US>) an easy-to-use individual control or automation software program can be produced for operating ECO devices. In order to be able to address from the program the RS 232/485 interface that is used LAUDA makes the drivers specially produced for LABVIEW® available free of charge for download at <http://www.lauda.de>.

19.8 Contact module

19.8.1 Contact module LRZ 914 with 1 input and 1 output

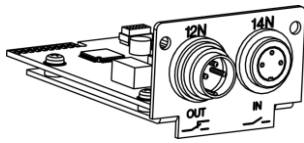

Contact module (catalogue no. LRZ 914) with connectors to NAMUR NE28, with 1 output and 1 input on each of 2 DIN sockets.

The inputs provide the following functions:

- **Error** Set error
- **Standby** Set standby
- **Control programmer** Control programmer (Input 1 activates the programmer. The programmer is started on the first "Close" and is put into "Hold" on "Open". The next "Close" triggers "Continue").
- **Change mode** Control change mode (the switching statuses of contact "Open" or "Closed" are assigned 2 different set-point temperatures)
- **Control mode** Control the Control mode (the switching statuses of input "Open" or "Closed" can have two different control temperature sources assigned to them, e.g. internal ↔ external control).

The outputs provide the following functions:

- **Error diagnosis** Signal various error statuses
- **Standby** Signal standby
- **Temperature range** Give the status of the actual temperature within a certain range (within ↔ outside):
- **Programmer** Give programmer status

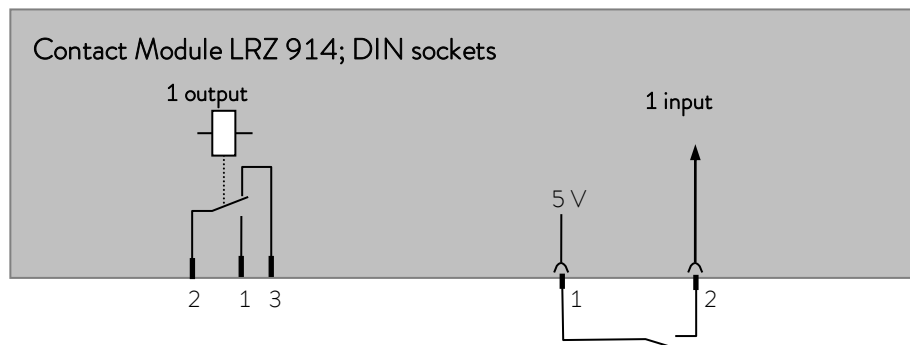

Contact outputs and inputs

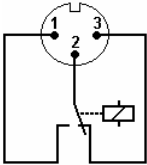
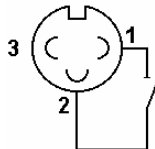
Output	Input
<ul style="list-style-type: none"> – View of flanged plug (front) or coupling-socket solder side – Max. 30 V; 0.2 A Coupling socket catalogue no. EQD 047	<ul style="list-style-type: none"> – View of socket (front) or solder side of plug – Signal approx. 5 V, 10 mA, do not assign Contact 3. Coupling plug catalogue no. EQS 048
 <p style="text-align: center;"> 1 = NO contact 2 = Center contact 3 = NC contact </p>	

Note: Only use screened connecting leads and connect the screen to the plug housing. Cover unused connectors with protective caps.

19.8.2 Contact module LRZ 915 with 3 inputs and 3 outputs

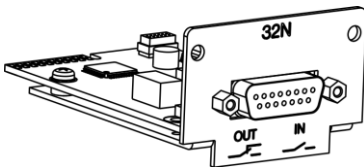

Contact module (catalogue no. LRZ 915) with 15-pole SUB-D socket. Range of functions as LRZ 914, but with three relay contact outputs (changeover, max. 30 V/0.2 A) and three binary inputs for control via external voltage-free contacts.

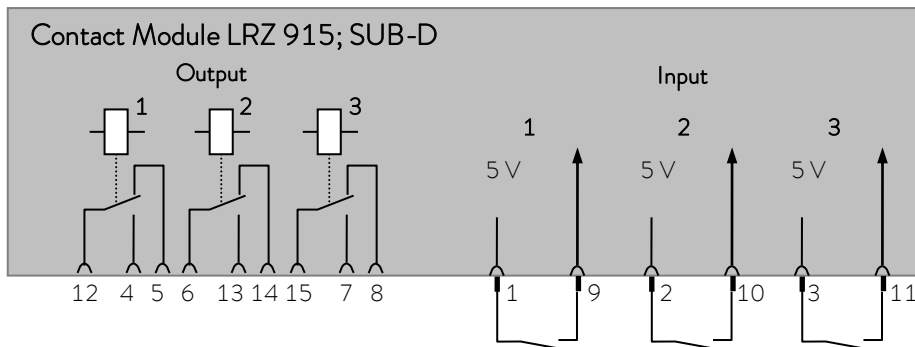

Contact inputs and outputs

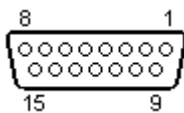

View of sockets on the plug side or of sockets on the solder side.

A suitable 15-pole Sub-D plug can be obtained together with a suitable housing under the catalogue no. EQM 030 (plug case catalogue no. EQG 017).

Blank page

Blank page

Product Returns and Clearance Declaration

Product Returns

Would you like to return a LAUDA product you have purchased to LAUDA? For the return of goods, e.g. for repair or due to a complaint, you will need the approval of LAUDA in the form of a *Return Material Authorization (RMA)* or *processing number*. You can obtain the RMA number from our customer service department at +49 (0) 9343 503 350 or by email service@lauda.de.

Return address

LAUDA DR. R. WOBSER GMBH & CO. KG

Laudaplatz 1

97922 Lauda-Königshofen

Deutschland/Germany

Clearly label your shipment with the RMA number. Please also enclose this fully completed declaration.

RMA number	Product serial number
Customer/operator	Contact name
Contact email	Contact telephone
Zip code	Place
Street & house number	
Additional explanations	

Clearance Declaration

The customer/operator hereby confirms that the product returned under the above-mentioned RMA number has been carefully emptied and cleaned, that any connections have been sealed to the farthest possible extent, and that there are no explosive, flammable, environmentally hazardous, biohazardous, toxic, radioactive or other hazardous substances in or on the product.

Place, date	Name in block letters	Signature

Version 02 - EN

LAUDA DR. R. WOBSE GMBH & CO. KG •Laudaplatz 1 •97922 Lauda-Königshofen
Tel.: +49 (0)9343 503-0 •Fax: +49 (0)9343 503-222
E-mail: info@lauda.de •Internet: <https://www.lauda.de>